

Copy
125 Pages

~~TOP SECRET~~

~~NO FOREIGN DISSEM~~

June 1965

TECHNICAL PUBLICATION

PHOTOGRAPHIC EVALUATION REPORT

MISSION 1015-1
19-24 DECEMBER 1964

MISSION 1015-2
25 DECEMBER 1964
28-30 DECEMBER 1964

Declassified and Released by the NRC

In Accordance with E. O. 12958

on NOV 26 1997

Handle Via ~~TALENT KEYHOLE~~ Control Only

8 JUL 65
LOGGED

WARNING

This document contains classified information affecting the national security of the United States within the meaning of the Espionage Laws, U. S. Code Title 18, Sections 793 and 794. The law prohibits its transmission or the revelation of its contents in any manner to an unauthorized person, as well as its use in any manner prejudicial to the safety or interest of the United States or for the benefit of any foreign government to the detriment of the United States. It is to be seen only by personnel especially indoctrinated and authorized by source TALENT KEYHOLE information; its security must be maintained in accordance with KEYHOLE and TALENT regulations.

NATIONAL PHOTOGRAPHIC INTERPRETATION CENTER



~~TOP SECRET~~

Handle Via
TALENT-KEYHOLE
Control System Only

~~TOP SECRET RUFF~~
~~NO FOREIGN DISSEM~~

TECHNICAL PUBLICATION

PHOTOGRAPHIC EVALUATION REPORT

MISSION 1015-1
19-24 DECEMBER 1964

MISSION 1015-2
25 DECEMBER 1964
28-30 DECEMBER 1964

June 1965

NATIONAL PHOTOGRAPHIC INTERPRETATION CENTER

~~TOP SECRET RUFF~~
~~NO FOREIGN DISSEM~~

Handle Via
TALENT-KEYHOLE
Control System Only

Handle Via
TALENT-KEYHOLE
Control System Only



TABLE OF CONTENTS

	Page
SYNOPSIS	1
GENERAL FLIGHT DATA	2
PART I. CAMERA OPERATION	3
1. Master (FWD) Panoramic Camera No 138	3
2. Slave (AFT) Panoramic Camera No 141	4
3. Master (FWD) Horizon Cameras	7
4. Slave (AFT) Horizon Cameras	7
5. Stellar Camera No 61 (Mission 1015-1)	7
6. Stellar Camera No 58 (Mission 1015-2)	7
7. Index Camera No D61 (Mission 1015-1)	8
8. Index Camera No D58 (Mission 1015-2)	8
9. Associated Equipment	8
PART II. FILM	9
1. Film Footage	9
2. Film Processing	9
3. Physical Film Degradations	10
4. Film Processing Curves	11
PART III. IMAGE QUALITY	23
1. Definition of Photographic Interpretation (PI) Suitability.	23
2. PI Suitability, Missions 1015-1 and 1015-2	24
3. Definition of Mission Information Potential (MIP)	25
4. MIP, Missions 1015-1 and 1015-2	26

Handle Via
TALENT-KEYHOLE
Control System Only



TABLE OF CONTENTS (CONTINUED)

	Page
APPENDIX A. SYSTEM SPECIFICATIONS	27
1. Cameras	27
2. Vehicle Configuration and Equipment Layout	30
3. Panoramic Format Configuration	31
4. Definition of Panoramic Format Calibrations	32
5. Panoramic Format Dimensions	34
6. Horizon Camera Settings	35
APPENDIX B. DENSITY READINGS	36
1. Stellar Camera No 61 (Mission 1015-1)	36
2. Index Camera No D61 (Mission 1015-1)	36
3. Stellar Camera No 58 (Mission 1015-2)	38
4. Index Camera No D58 (Mission 1015-2)	38
APPENDIX C. MICRODENSITOMETRY	39
1. Edge Spread Function	39
2. Edge Traces, Mission 1015-1	41
3. Edge Traces, Mission 1015-2	41
APPENDIX D. TEMPERATURE DATA	49
1. Summary of Temperature Effects, Mission 1015	49
2. Sensor Locations and In-Flight Temperature Samplings	49
APPENDIX E. CLOUD COVER ANALYSIS	59
1. Introduction	59
2. Cloud Cover Data, Missions 1015-1 and 1015-2	61

Handle Via
~~TALENT KEYHOLE~~
Control System Only



LIST OF ILLUSTRATIONS

	Page
Figure 1. Description of Photographic Data	8a
Figure 2. Example of Horizon Camera Photography	8c
Figure 3. Example of Stellar Camera Photography	8e
Figure 4. Example of Index Camera Photography	8g
Figure 5. Example of Out-of-Focus Condition in Aft Panoramic Photography	8i
Figure 6. Example of Unusual Scratch Degradation	10a
Figure 7. MIP Selection, Mission 1015-1	26a
Figure 8. MIP Selection, Mission 1015-2	26c
Figure 9. Example of Master (FWD) Panoramic Camera Photographic Quality	26e
Figure 10. Example of Slave (AFT) Panoramic Camera Photographic Quality	26g
Figure 11. Fixed Resolution Target, Indian Springs, Nevada . . .	26i
Figure 12. Example of Sun-Flared Water and Associated Streaks . .	26k
Figure 13. Target, Microdensitometric Trace No 1	42a
Figure 14. Target, Microdensitometric Traces Nos 2 and 3	44a
Figure 15. Target, Microdensitometric Traces Nos 4 and 5	46a

Handle Via
~~TALENT KEYHOLE~~
Control System Only

Handle Via
~~TALENT-KEYHOLE~~
Control System Only

SYNOPSIS

Mission 1015^o (System No J-17) the 15th of the "J" reconnaissance series was launched 19 December 1964. Two operational phases were programmed and designated Missions 1015-1 and 1015-2, respectively.

Mission 1015-1 (19-24 December 1964) accomplished 39 photographic revolutions, including 3 engineering and 4 domestic passes. The first-phase payload was recovered by air catch on 24 December and second-phase photography was initiated on 25 December 1964. Operations were suspended upon completion of pass 89AE and the vehicle was commanded into a controlled deactivated mode. The vehicle was reactivated on 28 December 1964 and photographic operations resumed with pass 142D.

Mission 1015-2 (25 December and 28-30 December 1964) accomplished 30 photographic revolutions, including 5 engineering and 3 domestic passes. Termination of operations and payload recovery were effected on 30 December because the telemetry signalled potential electrical difficulties. However, operation subsequent to recovery of the payload indicated that a mission of normal duration could have been performed.

All cameras functioned satisfactorily and produced good-quality photography. The panoramic record was assigned a Mission Information Potential (MIP) rating of 85 and the photography, in general, is comparable to that achieved in Mission 1012, 17-23 October 1964. However, the slave (AFT) panoramic imagery is degraded by the presence of an out-of-focus area at the supply end of the data block edge of the format. This condition is first observed in pass 4D and is detectable, to some degree, in all following passes. Fortunately, the overall degradation is relatively minor. The affected area is not extensive in size or consistent in severity of degradation and is, at times, difficult to detect. A detailed discussion of this anomaly is contained in Item 2 of Part I Camera Operation.

Clouds obscured 33 percent of the panoramic photography obtained in Mission 1015-1 and increased to 45 percent in Mission 1015-2. Solar elevations ranged from 4 degrees to 69 degrees in Mission 1015-1 and from 2 degrees to 79 degrees in Mission 1015-2. However, most of the photography was acquired with solar elevations between 5 and 35 degrees.

Handle Via
~~TALENT-KEYHOLE~~
Control System Only

Handle Via
~~TALENT KEYHOLE~~
Control System Only



GENERAL FLIGHT DATA

Mission 1015-1	Launch Date	19 December 1964
	Recovery Date	24 December 1964
Mission 1015-2	Activation Date	25 December 1964
	Deactivation Period	26, 27 December 1964
	Reactivation Date	28 December 1964
	Recovery Date	30 December 1964

Orbital Parameters

Mission 1015-1 (Rev 10) Mission 1015-2 (Rev 145)

Period	90.535 Min	90.1996 Min
Perigee	96.56 nm	98.141 nm
Apogee	230.64 nm	220.27 nm
Eccentricity	0.01860	0.016977
Inclination Angle	74.973° N	74.96° N

Photographic Operations

	Mission 1015-1	Mission 1015-2
Operational Passes	32	22
Domestic Passes	4	3
Engineering Passes	3	5
Recovery Revolutions	81D	175D

Handle Via
~~TALENT KEYHOLE~~
Control System Only

Handle Via
~~TALENT-KEYMOLE~~
Control System Only

PART I. CAMERA OPERATION

1. Master (FWD) Panoramic Camera No 138:

The instrument was operational throughout the mission and camera-induced degradations consist mainly of various light-struck areas at the beginning and end of the photography acquired in each pass. The light leaks produced the following patterns in Mission 1015-1 (noted in order of appearance from head to tail of the individual pass records):

(a) 1st frame: a small flare inside the format, originating on the data block edge and generally found in the take-up half of the frame.

(b) 5th-from-last frame: an edge-to-edge plus-density area 3 to 6 inches wide.

(c) 4th-from-last frame: an irregular light trace resembling a corona static discharge, oriented toward take-up, and more intense on the data block edge of the film.

(d) Next-to-last frame: same as in (c) above, but generally less intense and more prominent on the frequency marks edge.

(e) Last frame: a small flare similar to that noted in the first frame, but less intense.

In Mission 1015-2 the following repetitive patterns are present:

(a) 1st frame: a small flare and/or a bar-type light trace approximately $\frac{1}{4}$ -inch wide, extending from edge to edge within the format.

(b) Next-to-last frame: a small, irregular light trace resembling a corona static discharge.

(c) Last frame: a faint equipment shadowgraph.

Degradation of imagery within the affected areas is minimal in most cases. However, in an isolated case outside the general pattern, heavy fog and dense equipment shadowgraphs severely degrade all of frame 5 and a portion of frame 6 in pass 142D.

Handle Via
~~TALENT-KEYMOLE~~
Control System Only

~~TOP SECRET RUFF~~

~~NO FOREIGN DISSEM~~

Handle Via
TALENT KEYHOLE
Control System Only

Intermittent, fine base scratches are present throughout the film. Both edges contain continuous rail scratches. There are no outstanding or excessive camera-induced emulsion scratches or abrasions.

2. Slave (AFT) Panoramic Camera No 141:

The camera was operational throughout the mission and the photographic record contains light-struck areas on the order of those noted in Item 1 above. Degradation is slight and will be discussed at a later point. A more notable anomaly is the presence of an out-of-focus area at the supply end of the data block edge of most formats following pass 4D, frame 25. Water, cloud cover, and atmospheric haze in the photography immediately following frame 25 preclude precise determination of the initial appearance of the degradation. Similar out-of-focus areas have been observed in a number of previous mission records, such as Missions 1004, 1007, 1010, 1011, where the degradation appeared almost exclusively in the master (FWD) camera material.

The area affected by the out-of-focus condition in this mission varies slightly in dimensions, contour, and severity of degradation, but its location within the format is reasonably stable. At worst, the degradation extends 4 inches along the edge of the format (taken from the supply end shrinkage marker and measured toward take-up) and intrudes approximately 1 inch into the format in an irregular curve.

The factors involved in this anomaly have not yet been positively established. However, extensive study has resulted in an apparent correlation between film tracking and presence of the out-of-focus condition, which seems to be induced by variations in pitch of the formats (their alignment on the film, relative to the film edges). For example, the format pitch measurements in the master (FWD) camera material are relatively stable and no degradation is detectable:

Pitch range @ take-up: 0.260" - 0.265". Average 0.265".

Pitch range @ supply: 0.215" - 0.230". Average 0.220".

(Note: Pitch values are measured from the format edge to the film edge immediately adjacent to the shrinkage markers at supply and take-up.)

Measurements of format pitch in the slave (AFT) camera material reveal that the take-up values are fairly stable, but the supply values are erratic and the out-of-focus condition appears to be induced by this variation. Sample readings and pertinent comments are tabulated, as follows:

- 4 -

Handle Via
TALENT KEYHOLE
Control System Only

~~TOP SECRET RUFF~~

~~NO FOREIGN DISSEM~~

Handle Via
~~TALENT KEYHOLE~~
Control System Only



<u>Pass</u>	<u>Frame</u>	<u>Pitch at Take-up (inches)</u>	<u>Pitch at Supply (inches)</u>	<u>Comments</u>
1D	1	0.250	0.250	Out-of-focus condition not present.
	5	0.250	0.240	
	10	0.255	0.245	
	14	0.255	0.255	
3D	1	0.255	0.240	Large displacement occurs at supply in frame 12, but water/clouds preclude detection of degradation.
	12	0.260	0.265	
	27	0.260	0.255	
4D	1	0.260	0.250	Degradation is readily detectable when supply pitch attains 0.2675 inches but not prior to that. Take-up pitch stabilized at 0.260 inches.
	25	0.255	0.267	
	50	0.260	0.2675	
	75	0.260	0.2675	
5D	1	0.260	0.2675	Haze precludes detection of degradation, frame 1. None present in frames 20 and 45.
	20	0.257	0.245	
	45	0.260	0.265	
6D	1	0.260	0.2675	Supply pitch measurement stabilizes at apparent critical value and degradation exists in all frames.
	50	0.260	0.2675	
	75	0.260	0.2675	

Numerous additional pitch readings were taken as the mission evaluation progressed but no significant departures from the apparent degradation pattern were observed. Summing up, it appears that the following conditions exist when degradation is present:

(a) A critical pitch measurement is attained, either by the supply or take-up end of the format. In this case, it is located at supply and the critical or threshold value is 0.2675 inches.

(b) The pitch differences between take-up and supply vary, but unless a critical displacement has taken place at one end or the other the take-up and supply pitch relationships are of little significance. In this mission the difference in pitch between take-up and supply ranges as high as 0.010 inches with an average difference of 0.0075 inches. Regardless, no degradation is detectable at any time unless the supply pitch reading is at the critical value.

Handle Via
~~TALENT KEYHOLE~~
Control System Only

Handle Via
~~TALENT KEYHOLE~~
Control System Only

The reader is cautioned that the foregoing conclusions are derived from study of the film record of Mission 1015 only. Exhaustive study of previous mission records is currently underway and will provide more detailed information and data on the relationship between film tracking and presence of the focus anomaly.

The following light-induced degradations are present in the aft camera material, Mission 1015-1 (noted in most passes):

(a) 7th-from-last frame: a plus density area near supply, which occasionally shifts into the take-up end of the 6th frame from last.

(b) 6th-from-last frame: an intense corona-type light trace, which also affects the 5th-from-last frame in a number of cases.

(c) 3rd-from-last frame: a smaller, less intense corona-type light trace and a faint equipment shadowgraph.

(d) 2nd-from-last frame: a faint equipment shadowgraph at supply, which occasionally shifts into the take-up end of the next-to-last frame.

(e) Next-to-last frame: a small corona-type light trace.

In Mission 1015-2 the following frames of most passes are affected:

(a) 1st frame: a faint equipment shadowgraph at take-up.

(b) Next-to-last frame: a small light trace.

(c) Last frame: faint equipment shadowgraphs in a number of passes.

The aft photography exhibits banding at the start of scan in most frames. This has been observed in previous mission records. In addition, the aft material contains intermittent minus density streaks. However, neither condition appreciably degrades the imagery.

Handle Via
~~TALENT KEYHOLE~~
Control System Only

Handle Via
~~TALENT-KEYHOLE~~
Control System Only

3. Master (FWD) Horizon Cameras:

The port (supply) and starboard (take-up) horizon cameras were operational throughout the mission. The image corners are vignetted, but the horizon curves are unaffected and remain usable for determination of vehicle attitude. Exposure was adequate except where low solar elevations precluded effective horizon photography.

4. Slave (AFT) Horizon Cameras:

The port (take-up) and starboard (supply) horizon cameras were operational throughout the mission. Quality of the photography is similar to that obtained with the Master (FWD) instruments. The corner vignetting does not deny use of the horizon curves for the purpose of vehicle attitude determination, and exposure was adequate except where low solar elevations prevailed.

5. Stellar Camera No 61 (Mission 1015-1):

The instrument was operational throughout the mission, but approximately 50 percent of each format is degraded by assorted flares and lens element reflections. At least 30 stellar images are recorded, but the majority of frames contain doublets and/or elongated stellar images. Uncertainty of mensuration is approximately 15 minutes of arc. The title edge of the film contains fine, transverse emulsion cracks which extend 0.10 inch into the film (frames 50-384). Fine, edge-to-edge emulsion cracks are present in frames 160-384. Minor abrasions appear intermittently on the title edge but no sequence of occurrence is definable.

6. Stellar Camera No 58 (Mission 1015-2):

The camera performed satisfactorily throughout the mission. A double exposure occurred in the first frame, but is not classified as a malfunction. This anomaly is occasionally induced by the camera programmer at the start of the second phase of a two-section mission, dependent on the position of the camera programmer at launch. Of the 7 possible positions, 3 may cause double exposure of the initial second-phase frame. Quality of the photography is similar to that achieved in Mission 1015-1. The various degradations noted in the first-phase stellar record are also present in this material. In addition, minor dendritic static discharges are present at the end of the film record.

Handle Via
~~TALENT-KEYHOLE~~
Control System Only

Handle Via
TALENT-KEYHOLE
Control System Only

7. Index Camera No D61 (Mission 1015-1):

The camera was operational throughout the mission and produced good-quality photography.

8. Index Camera No D58 (Mission 1015-2):

The camera operated satisfactorily throughout the mission and quality of the photography is good. As in the stellar material, the first frame contains a double exposure.

9. Associated Equipment:

The binary data block was operational throughout the mission. No lamp failures were noted except in pass 167D, frame 27, where the time word is not recorded. However, the index lamp image adjacent to the camera number in the master (FWD) panoramic camera material is bloomed and the entire data block in the slave (AFT) film contains bloomed lamp images, resulting in non-uniform image sizes and shapes. The frequency marks are flared, but are recorded outside the formats. Single end-of-pass markers are recorded at all camera-off positions. The camera numbers are flared but readable. The horizon camera fiducials are well defined, with little or no flare present.

Handle Via
TALENT-KEYHOLE
Control System Only

FIGURE 1. DESCRIPTION OF PHOTOGRAPHIC DATA.

The data pertaining to photographs contained in this publication are defined as follows:

PASS: A pass is the operational portion of an orbital revolution. A suffix D indicates that the photography was acquired during the descending portion, a suffix A indicates that the photography was acquired during the ascending portion, and a suffix M indicates that the photography was acquired during a pass that includes both ascending and descending portions. An additional suffix E indicates that the pass was an engineering operation or that a portion of the pass has been edited.

DATE OF PHOTOGRAPHY: The date of photography indicates the day, month, and year (GMT) that the photography was acquired.

UNIVERSAL GRID COORDINATES: These coordinates are included to locate the illustrated photography within the panoramic format.

ENLARGEMENT FACTOR: The enlargement factor is included to indicate the number of diameters the original material has been enlarged in the photographic illustration.

GEOGRAPHIC COORDINATES: These coordinates are included to indicate the latitude and longitude of the panoramic format.

ALTITUDE: This measurement is the vertical distance from the vehicle to the Hough Ellipsoid at the time of the acquisition of the photography.

PITCH: Rotation of the camera about its transverse axis. Using appropriate aeronautical terminology, positive readings indicate nose-up attitude and negative readings indicate nose-down attitude.

ROLL: Rotation of the camera about its longitudinal axis. Using appropriate aeronautical terminology, positive readings indicate left wing-up attitude and negative readings indicate right wing-up attitude.

~~TOP SECRET RUFF~~

NO FOREIGN DISSEM

Handle Via
~~TALENT-KEYHOLE~~
Control System Only

YAW: - Rotation of the camera about its vertical axis. Positive readings indicate counterclockwise rotation when viewing the ground nadir from the vehicle-mounted camera in-flight.

LOCAL SUN TIME: This time is included to present to the viewer a realistic time of acquisition of the photography illustrated.

SOLAR ELEVATION: The solar elevation is the angular elevation of the sun above a plane tangent to the surface of the earth at the center of the panoramic format. A negative solar elevation indicates that the sun is below the plane.

SOLAR AZIMUTH: The solar azimuth is the angular measurement of the rays of the sun measured from True North in a clockwise direction.

EXPOSURE: The exposure is the duration of the photographic exposure expressed in a fraction of a second and is computed from the scan rate and slit width.

- 80 -

~~TOP SECRET RUFF~~

NO FOREIGN DISSEM

Handle Via
~~TALENT-KEYHOLE~~
Control System Only

Handle Via
~~TALENT KEYHOLE~~
Control System Only

~~TOP SECRET RUFF~~

~~NO FOREIGN DISSEM~~

FIGURE 2. EXAMPLE OF HORIZON CAMERA PHOTOGRAPHY.

NPIC K-1888 (8/88)

- 8c -

~~TOP SECRET RUFF~~

~~NO FOREIGN DISSEM~~

Handle Via
~~TALENT KEYHOLE~~
Control System Only

Handle Via
~~TALENT-KEYHOLE~~
Control System Only



Camera	FWD
Pass	47DE
Frame	9
Date of Photography	22 December 1964
Universal Grid Coordinates	Port Horizon
Enlargement Factor	3X
Geographic Coordinates	36-23N 114-28W
Altitude (feet)	603,816
Camera Altitude		
Pitch	15°14'
Roll	-00°23'
Yaw	00°16'
Local Sun Time	1233 Hours
Solar Elevation	29°44'
Solar Azimuth	171°
Exposure	1/100 Sec



Approximate flight direction
on photograph



Approximate scan direction
on photograph

Approximate location of photograph in format. Negative viewed with emulsion side down.



Handle Via
~~TALENT-KEYHOLE~~
Control System Only

Handle Via
TALENT-KEYHOLE
Control System Only

~~TOP SECRET - RUFF~~
~~NO FOREIGN DISSEM~~



~~TOP SECRET - RUFF~~
~~NO FOREIGN DISSEM~~

Handle Via
TALENT-KEYHOLE
Control System Only

Handle Via
~~TALENT KEYHOLE~~
Control System Only

~~TOP SECRET RUFF~~
NO FOREIGN DISSEM

FIGURE 3. EXAMPLE OF STELLAR CAMERA PHOTOGRAPHY.

NPIC K-1884 (8/68)

- 8e -

~~TOP SECRET RUFF~~
NO FOREIGN DISSEM

Handle Via
~~TALENT KEYHOLE~~
Control System Only

Handle Via
TRENT-KEYHOLE
Control System Only



Stellar Frame Number 48 & 49
Correlates with FWD Camera:
Pass 850
Frame 103 & 110
Date of Photography 25 December 1964
Enlargement Factor 3X
Panoramic Camera Attitude During Acquisition
Pitch 15°09' 15°12'
Roll -00°14' -00°17'
Yaw 00°12' 00°17'
Exposure Time 2 Sec

Handle Via
TRENT-KEYHOLE
Control System Only

Handle Via
~~TACTICAL KEYHOLE~~
Control System Only

~~TOP SECRET - RUFF~~
~~NO FOREIGN DISSEM~~

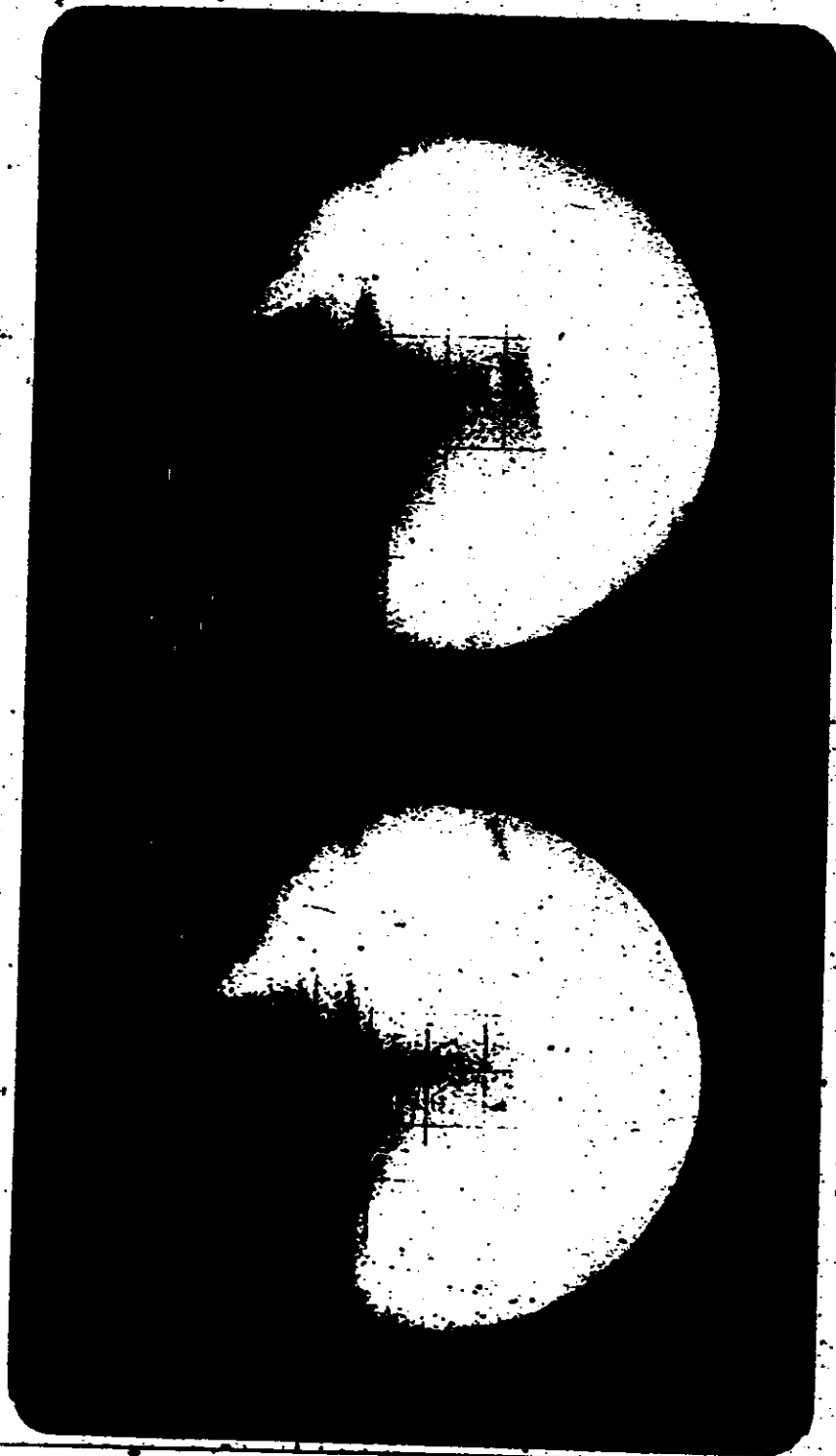

~~TOP SECRET - RUFF~~
~~NO FOREIGN DISSEM~~

Handle Via
~~TACTICAL KEYHOLE~~
Control System Only

~~TOP SECRET RUFF~~

~~NO FOREIGN DISSEM~~

Handle Via
~~TALENT-KEYHOLE~~
Control System Only



FIGURE 4. EXAMPLE OF INDEX CAMERA PHOTOGRAPHY.

NPIC X-1888 (8/88)

8g

~~TOP SECRET RUFF~~

~~NO FOREIGN DISSEM~~

Handle Via
~~TALENT-KEYHOLE~~
Control System Only

Handle Via
~~TALENT KEYHOLE~~
Control System Only.



Index Frame Number 13
Correlates with FWD Camera:
 Pass 40
 Frame 43
Date of Photography 20 December 1964
Enlargement Factor 3X
Panoramic Attitude During Acquisition
 Pitch 15°09'
 Roll -00°26'
 Yaw 00°39'
Exposure 1/500 Sec

Handle Via
~~TALENT KEYHOLE~~
Control System Only

Handle Via
TAL ENT KEYHOLE
Control System Only

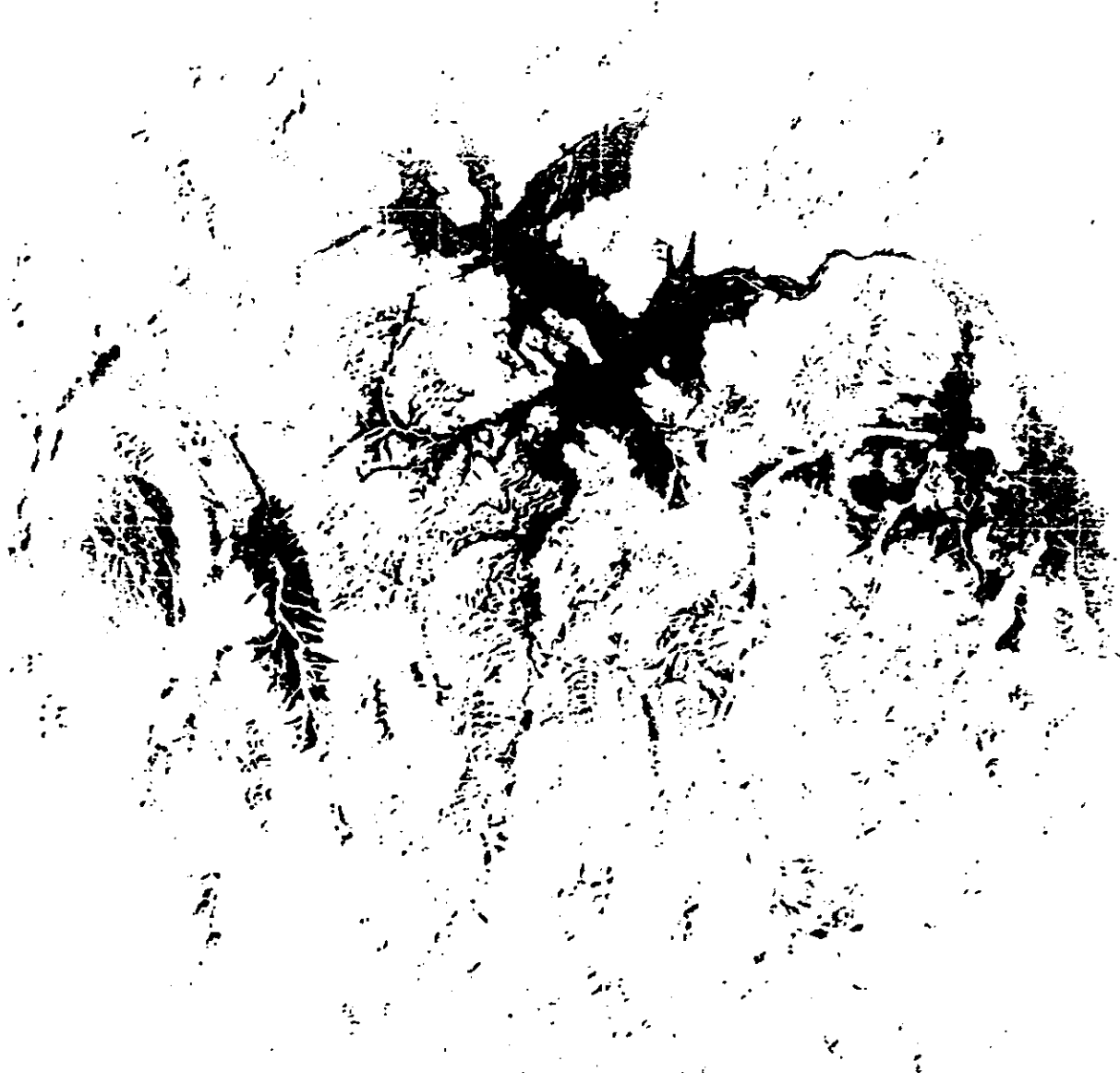

013

1015-1 20 DEC 64

~~TOP SECRET RUFF~~

Handle Via
TAL ENT KEYHOLE
Control System Only

~~TOP SECRET RUFF~~

~~NO FOREIGN DISSEM~~

Handle Via
~~TALENT KEYHOLE~~
Control System Only



FIGURE 5. EXAMPLE OF OUT-OF-FOCUS CONDITION IN AFT PANORAMIC PHOTOGRAPHY.

NPIC K-1886 (8/68)

- 81 -

Handle Via
~~TALENT KEYHOLE~~
Control System Only

~~TOP SECRET RUFF~~

~~NO FOREIGN DISSEM~~

Handle Via
TALENT-KEYHOLE
Control System Only



Camera	AFT
Pass	47DE
Frame	34
Date of Photography	22 December 1964
Universal Grid Coordinates	10-20, Fiducial Edge
Enlargement Factor	2X
Geographic Coordinates	33-16N 113-28W
Altitude (feet)	597,113
Camera Altitude		
Pitch	Not Available
Roll	Not Available
Yaw	Not Available
Local Sun Time	1237 Hours
Solar Elevation	32° 39'
Solar Azimuth	170°
Exposure	1/400 Sec
Location of photo in frame (note inked area)		

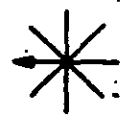

Approximate flight direction
on photograph

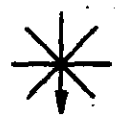

Approximate scan direction
on photograph

Approximate location of photograph in format. Negative viewed with emulsion side down.

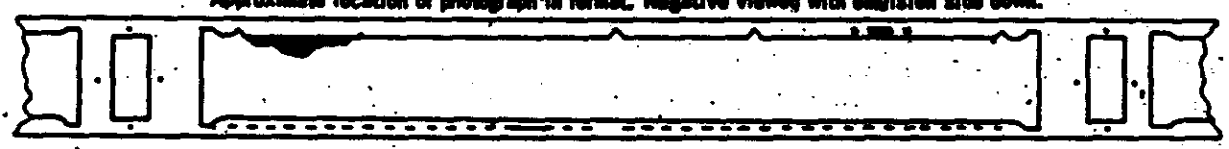

Handle Via
TALENT-KEYHOLE
Control System Only

~~TOP SECRET - RUFF~~
~~NO FOREIGN DISSEM~~

Handle Via
~~TALENT KEYHOLE~~
Control System Only



~~TOP SECRET - RUFF~~
~~NO FOREIGN DISSEM~~

Handle Via
~~TALENT KEYHOLE~~
Control System Only

Handle Via
TALENT-KEYHOLE
Control System Only

PART II. FILM

1. Film Footage:

The film footage/frame totals for Mission 1015 are as follows:

	1015-1	1015-2
Master (FWD) Panoramic Camera	7,826 ft/2,690 frames	7,067 ft/2,664 frames
Slave (AFT) Panoramic Camera	7,706 ft/2,648 frames	7,019 ft/2,654 frames
Stellar Camera	61 ft/ 384 frames	53 ft/ 379 frames
Index Camera	104 ft/ 384 frames	78 ft/ 379 frames
<hr/>		
Total Footage/Frames, Master (FWD) Panoramic Camera	14,893 ft/5,354 frames	
Total Footage/Frames, Slave (AFT) Panoramic Camera	14,725 ft/5,302 frames	
Total Footage/Frames, Panoramic Photography	29,618 ft/10,856 frames	

Note: All footage figures are process machine footages.

2. Film Processing:

This section provides evaluation of processing, exposure, density, contrast, and physical condition of the original negatives. Processing data are abstracted from records maintained by the processing contractor. Evaluation of exposure and physical condition of the processed film are accomplished by on-site inspection of the negative material as it is made available for breakdown and titling. A final, more thorough examination of the original negatives is conducted by photographic analysts at a later date.

In general, most of the photography obtained in this mission received adequate exposure. However, low solar elevations and/or variations in terrain reflectivity caused some departures from normal. Densities range from thin (in photography acquired at low solar elevations) to medium. The contrast varies from low to medium, dependent on solar elevation, terrain type, cloud shadow, and similar related factors. Some high contrast photography is present in snow-covered areas (particularly in mountainous terrain) and in shoreline areas. The physical condition of the processed film was good.

Handle Via
TALENT-KEYHOLE
Control System Only

Handle Via
~~TALENT KEYHOLE~~
Control System Only

The following development levels were employed in processing the film:

	1015-1		1015-2	
	Master	Slave	Master	Slave
Primary	2%	0%	0%	0%
Intermediate	2%	5%	10%	9%
Full	96%	95%	90%	91%

Four development level changes were made in processing the master record and 11 changes in the slave record, Mission 1015-1. In Mission 1015-2, the master film record required 18 development level changes and the slave record 10. Nine parts were special-printed in Mission 1015-1 and 6 parts required similar treatment in Mission 1015-2.

3. Physical Film Degradations:

There are no outstanding or excessive physical degradations other than an unusual, arrow-shaped scratch in frame 25 of pass 880. The scratch is oriented to the long axis of the film with the "arrowhead" projected towards the take-up end of the format. Slightly curved, the scratch is approximately 0.40 inch long and 0.05 inch wide. Location of the scratch is 0.50 inch inboard of the frequency marks edge and 11.50 inches from take-up. Image destruction is severe; several buildings and a section of road have been obliterated. Investigation indicates that the degradation occurred after the film had been processed, inspected, and titled. More precise determination of the time the damage was caused is not possible.

Handle Via
~~TALENT KEYHOLE~~
Control System Only

Handle Via
~~TALENT KEYHOLE~~
Control System Only

~~TOP SECRET RUFF~~
NO FOREIGN DISSEM



FIGURE 6. EXAMPLE OF UNUSUAL SCRATCH DEGRADATION.

NPIC K-1887 (8/68)

- 10a -

Handle Via
~~TALENT KEYHOLE~~
Control System Only

~~TOP SECRET RUFF~~
NO FOREIGN DISSEM

Handle Via
~~TALENT-KEYHOLE~~
Control System Only



Camera	FWD
Pass	88D
Frame	25
Date of Photography	25 December 1964
Universal Grid Coordinates	54-10 (Scratch Center)
Enlargement Factor	20X
Geographic Coordinates	Not Applicable
Altitude (feet)	Not Applicable
Camera Altitude	
Pitch	Not Applicable
Roll	Not Applicable
Yaw	Not Applicable
Local Sun Time	Not Applicable
Solar Elevation	Not Applicable
Solar Azimuth	Not Applicable
Exposure	Not Applicable

Approximate location of photograph in format. Negative viewed with emulsion side down.



Handle Via
~~TALENT-KEYHOLE~~
Control System Only

~~TOP SECRET - RUFF~~
~~NO FOREIGN DISSEM~~

Handle Via
TALENT-KEYHOLE
Control System Only



~~TOP SECRET - RUFF~~
~~NO FOREIGN DISSEM~~

Handle Via
TALENT-KEYHOLE
Control System Only

~~TOP SECRET RUFF~~

~~NO FOREIGN DISSEM~~

Handle Via
~~TALENT KEYHOLE~~
Control System Only

4. Film Processing Curves:

The following graphs are reproductions of the film processing curves for missions 1015-1 and 1015-2 provided by the processing contractor.

- 11 -

~~TOP SECRET RUFF~~

~~NO FOREIGN DISSEM~~

Handle Via
~~TALENT KEYHOLE~~
Control System Only

Handle Via
~~TALENT-KEYHOLE~~
Control System Only

STANDARD PROCESSING CONTROL CURVES

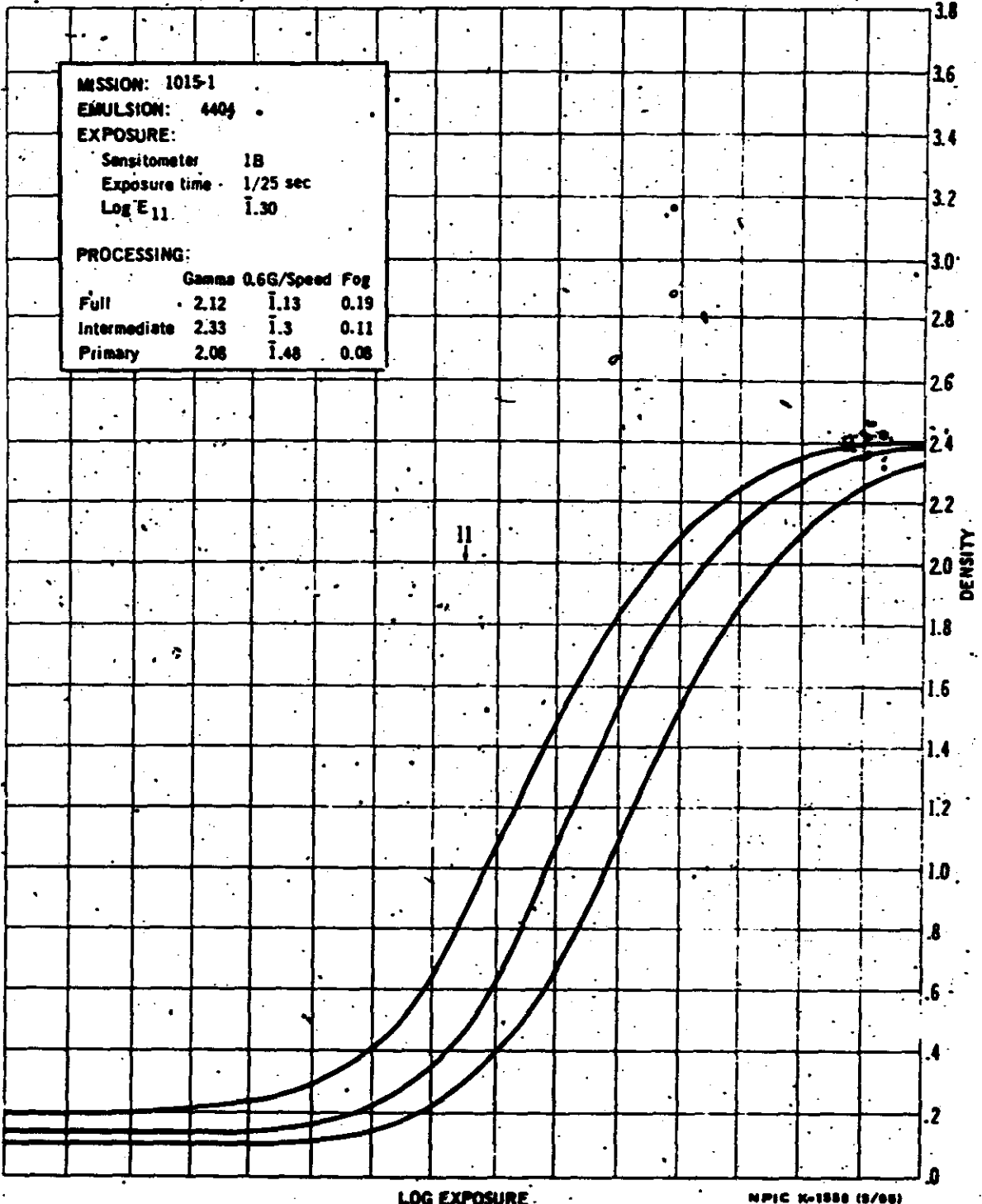

LOG EXPOSURE

NPIC K-1888 (8/68)

Handle Via
~~TALENT-KEYHOLE~~
Control System Only

Handle Via
TALENT KEYHOLE
Control System Only

CONTROL CURVE FOR HEAD AND TAIL OF FORWARD MATERIAL

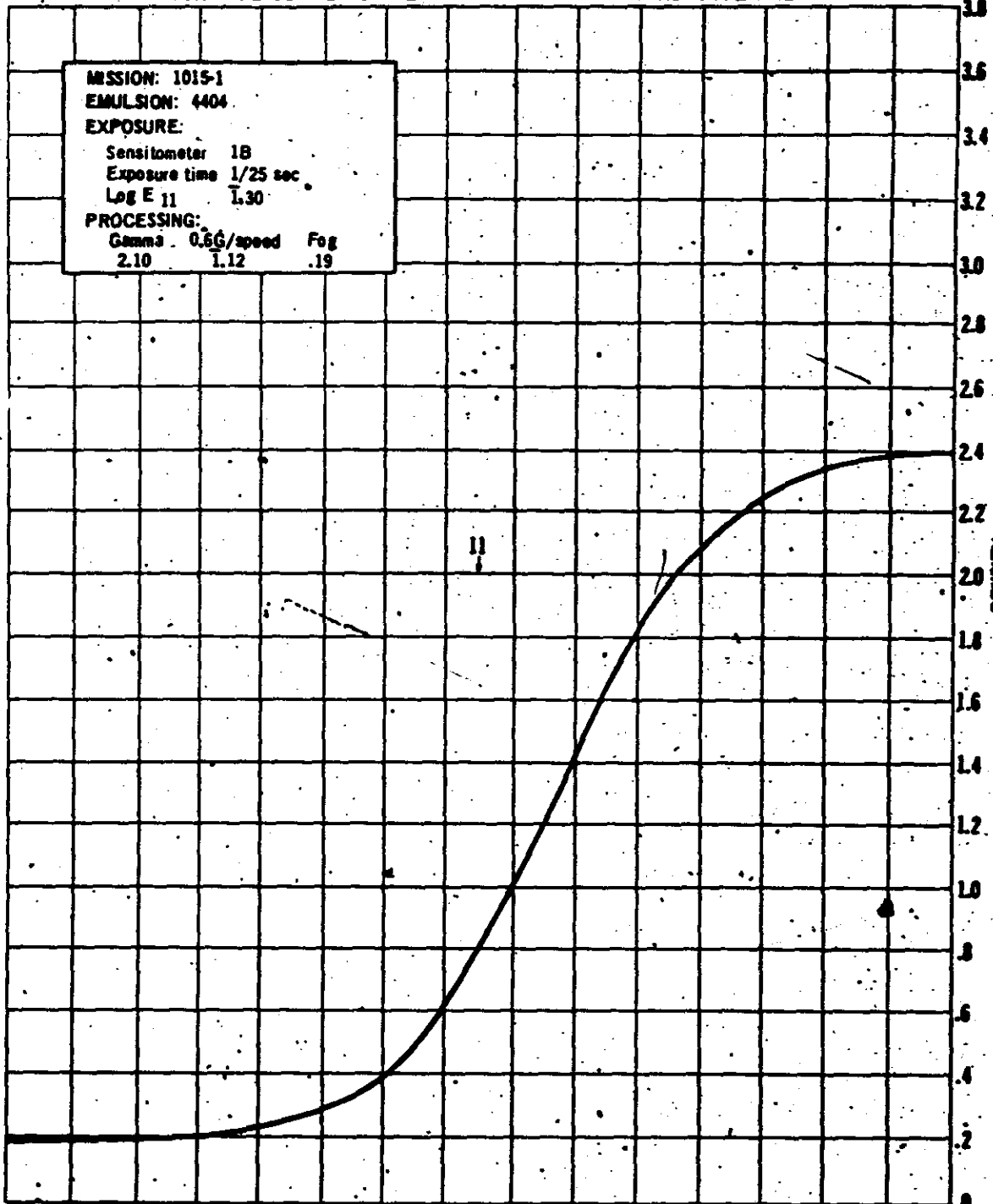

MISSION: 1015-1
 EMULSION: 4404
 EXPOSURE:
 Sensitometer 1B
 Exposure time 1/25 sec
 Log E 11 1.30
 PROCESSING:
 Gamma 0.66/speed Fog
 2.10 1.12 .19

LOG EXPOSURE

NPIC N-1888 (8/68)

Handle Via
TALENT KEYHOLE
Control System Only

Handle Via
~~TALENT-KEYHOLE~~
Control System Only



CONTROL CURVE FOR HEAD AND TAIL OF AFT MATERIAL

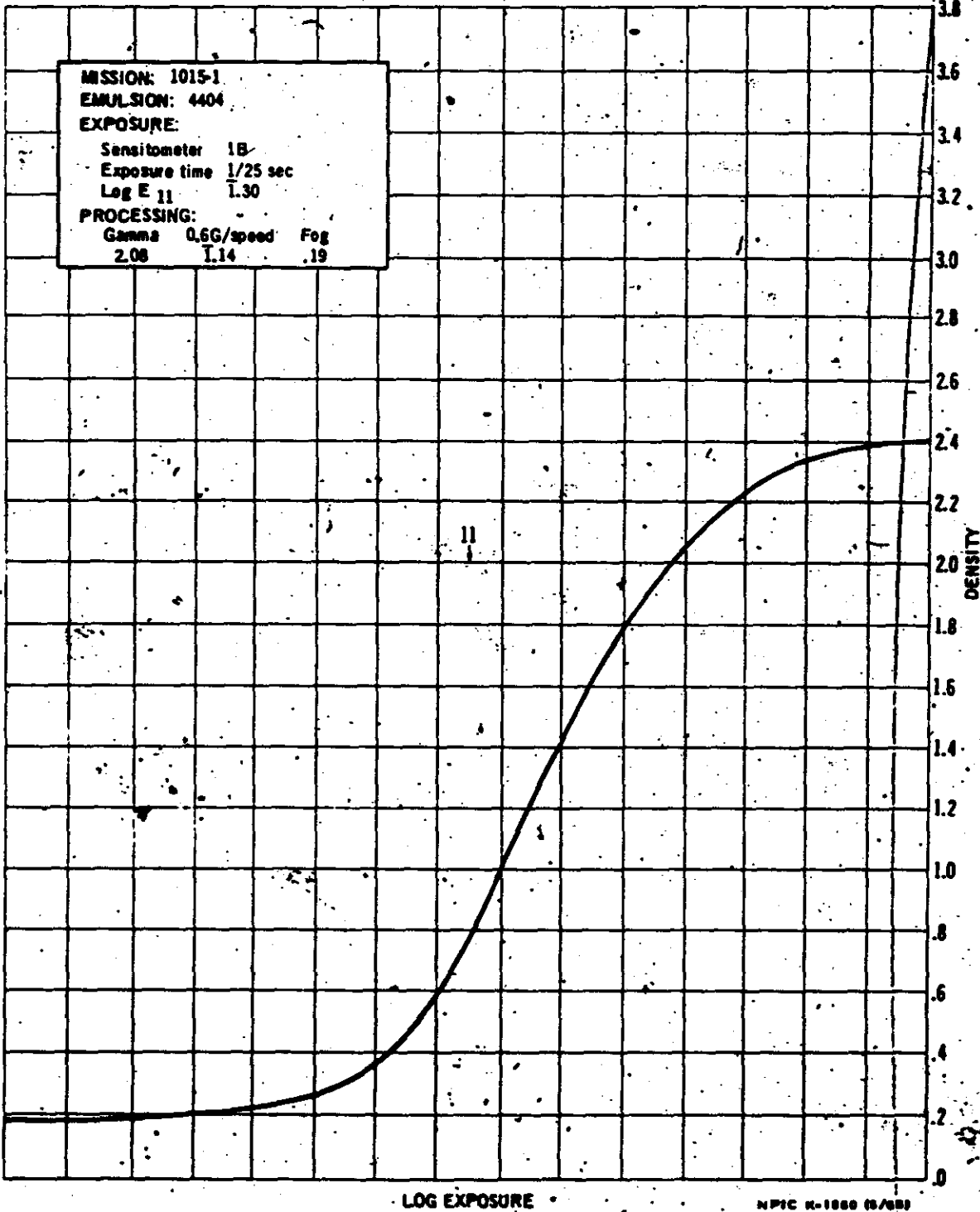

LOG EXPOSURE

NPIC N-1000 (8/68)

Handle Via
~~TALENT-KEYHOLE~~
Control System Only

Handle Via
~~TALENT-KEYHOLE~~
Control System Only

SENSITOMETRIC CURVE FROM MISSION MATERIAL

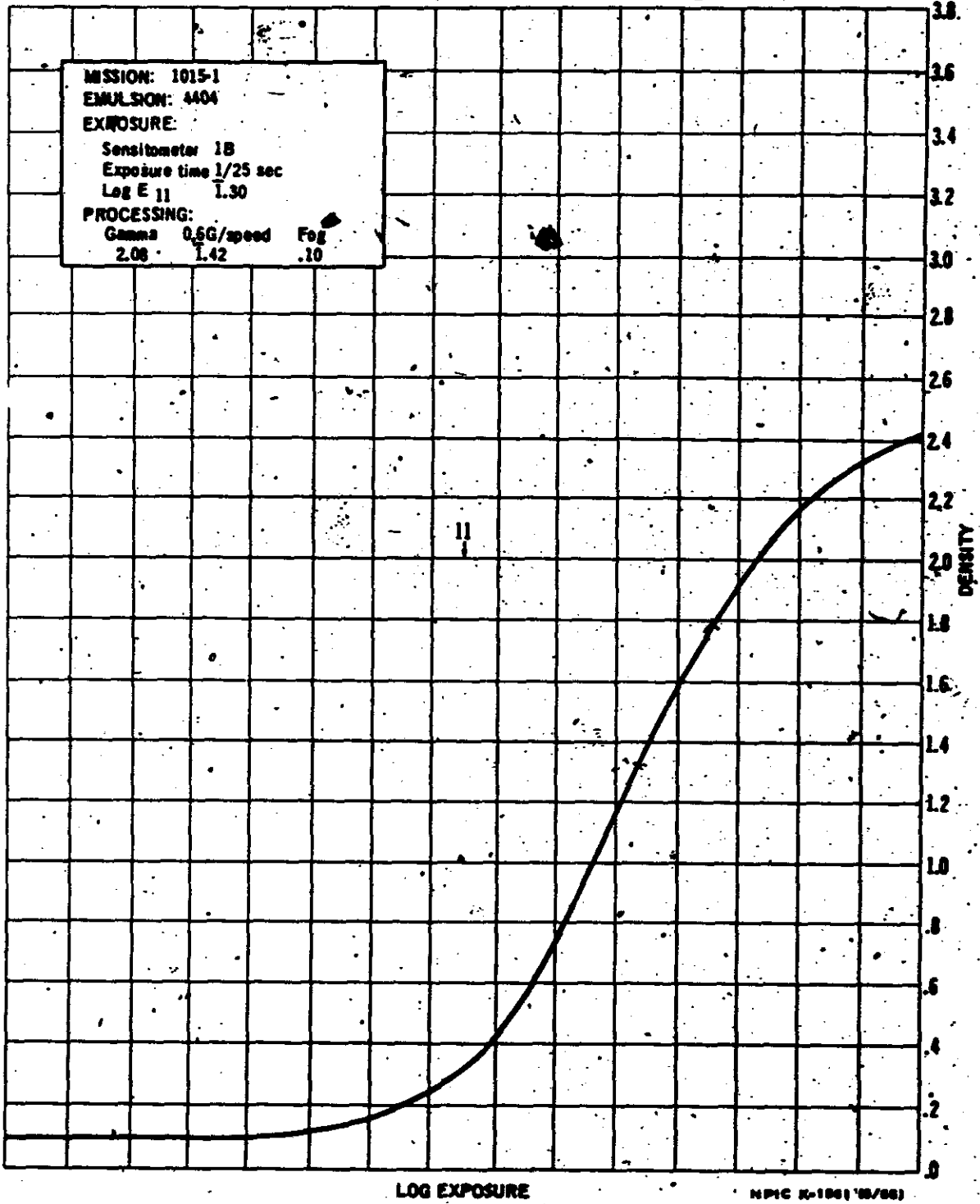

LOG EXPOSURE

DENSITY

Handle Via
~~TALENT-KEYHOLE~~
Control System Only

Handle Via
~~TALENT-KETHOLE~~
Control System Only



CONTROL CURVE FOR HEAD AND TAIL OF MISSION MATERIAL

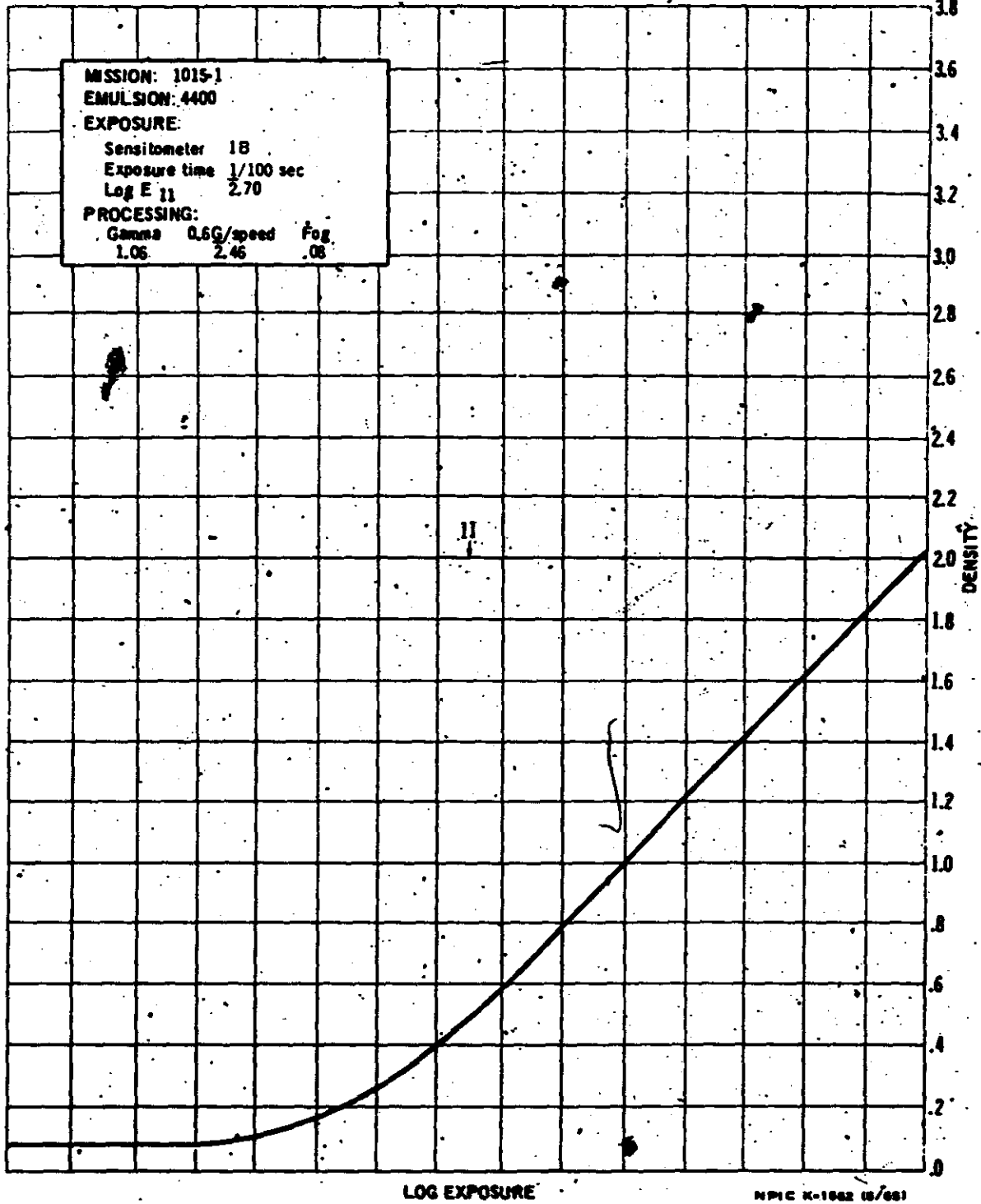

LOG EXPOSURE

NPIC K-1062 (8/68)

Handle Via.
~~TALENT-KETHOLE~~
Control System Only

Handle Via
TALENT-KEYHOLE
Control System Only

CONTROL CURVE FOR HEAD AND TAIL OF STELLAR MATERIAL

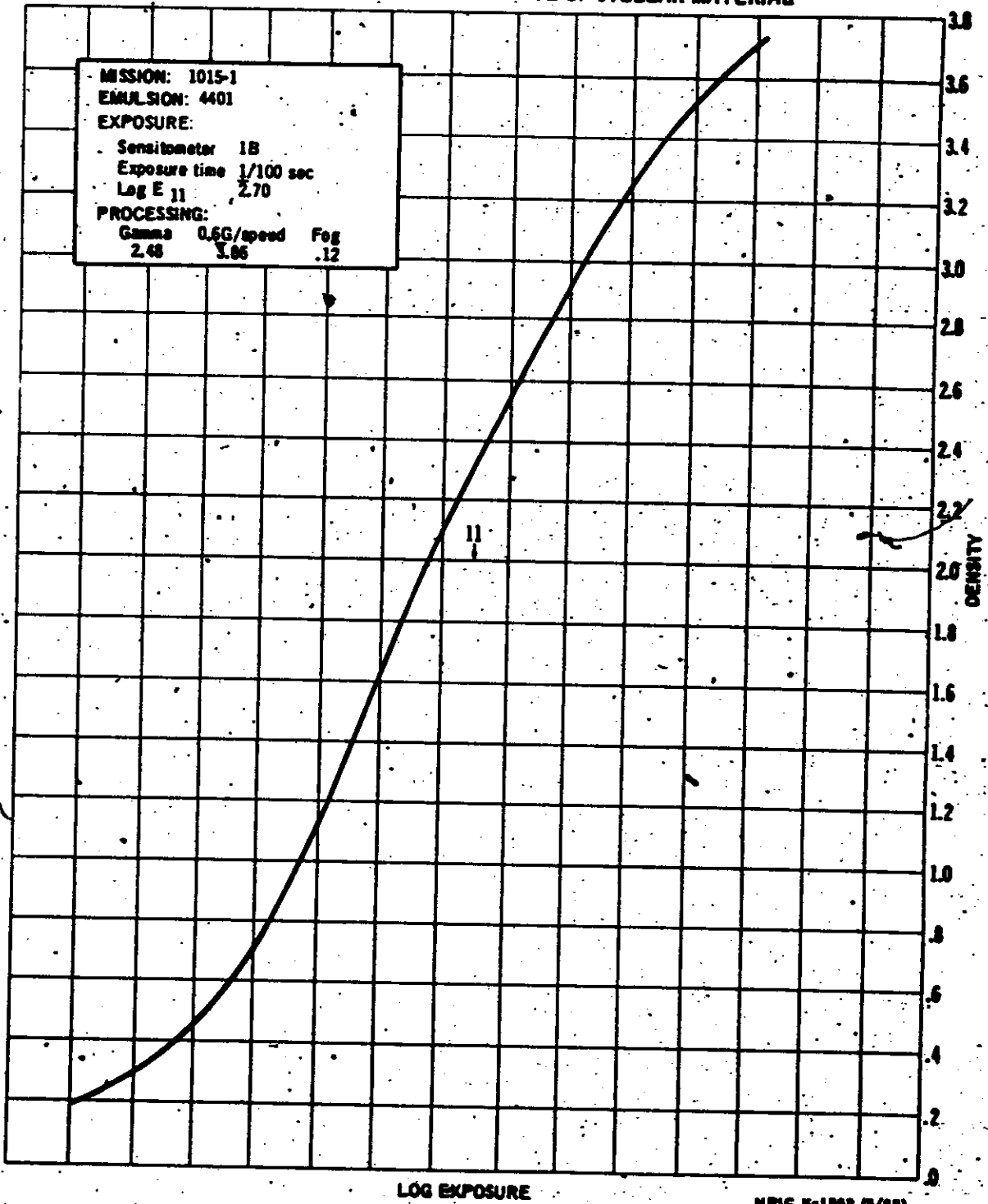

NPIC R-1989 (8/80)

Handle Via
TALENT-KEYHOLE
Control System Only

Handle Via
TALENT-KEYHOLE
Control System Only

STANDARD PROCESSING CONTROL CURVES

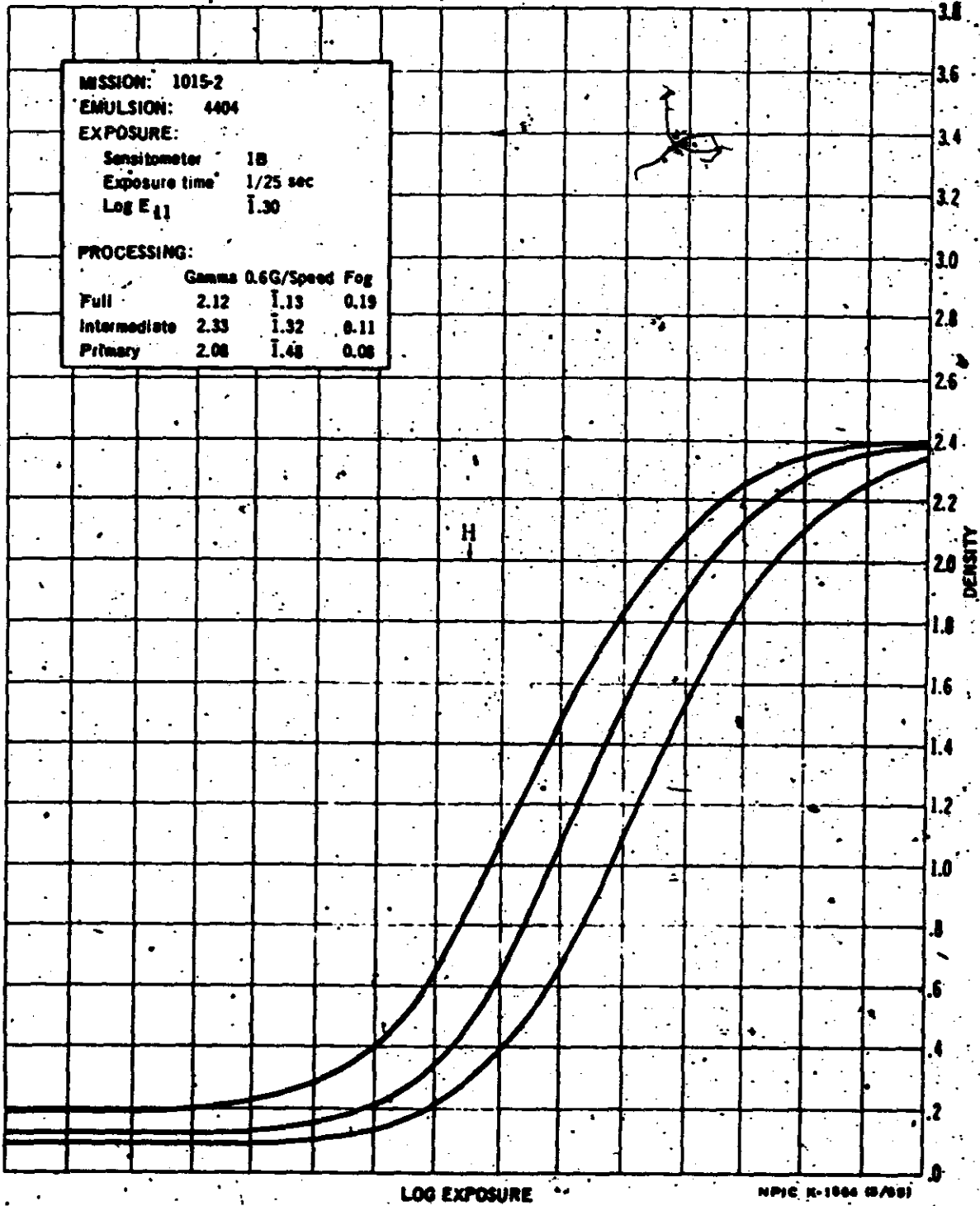

LOG EXPOSURE

NPIC K-1066 (8/68)

Handle Via
TALENT-KEYHOLE
Control System Only

Handle Via
~~TALENT-KEYHOLE~~
Control System Only

CONTROL CURVE FOR HEAD AND TAIL OF FORWARD MATERIAL

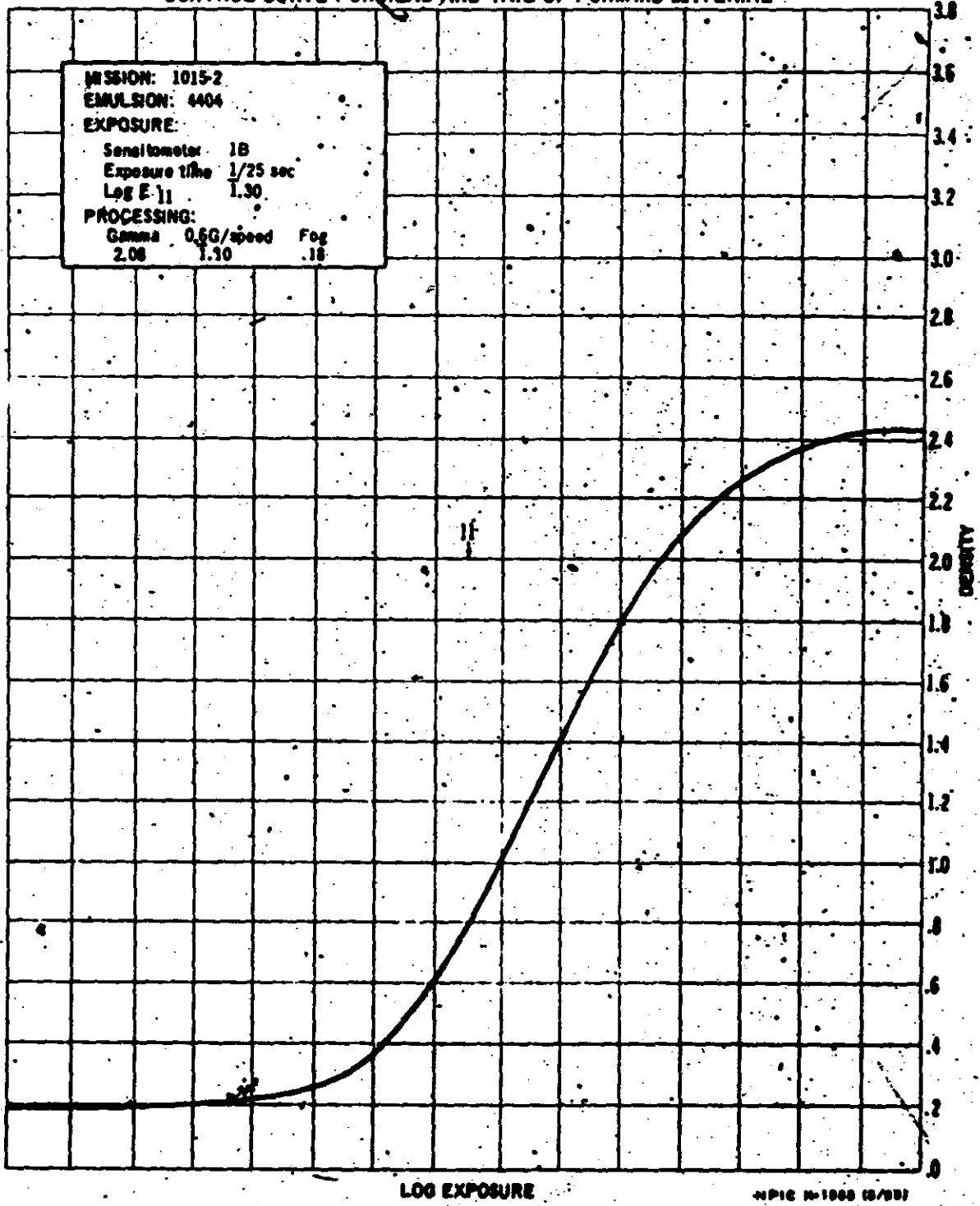

LOG EXPOSURE

NPIC N-1000 (5/67)

Handle Via
~~TALENT-KEYHOLE~~
Control System Only

Handle Via
VALENTYKETHOLE
Control System Only



CONTROL CURVE FOR HEAD AND TAIL OF AFT MATERIAL

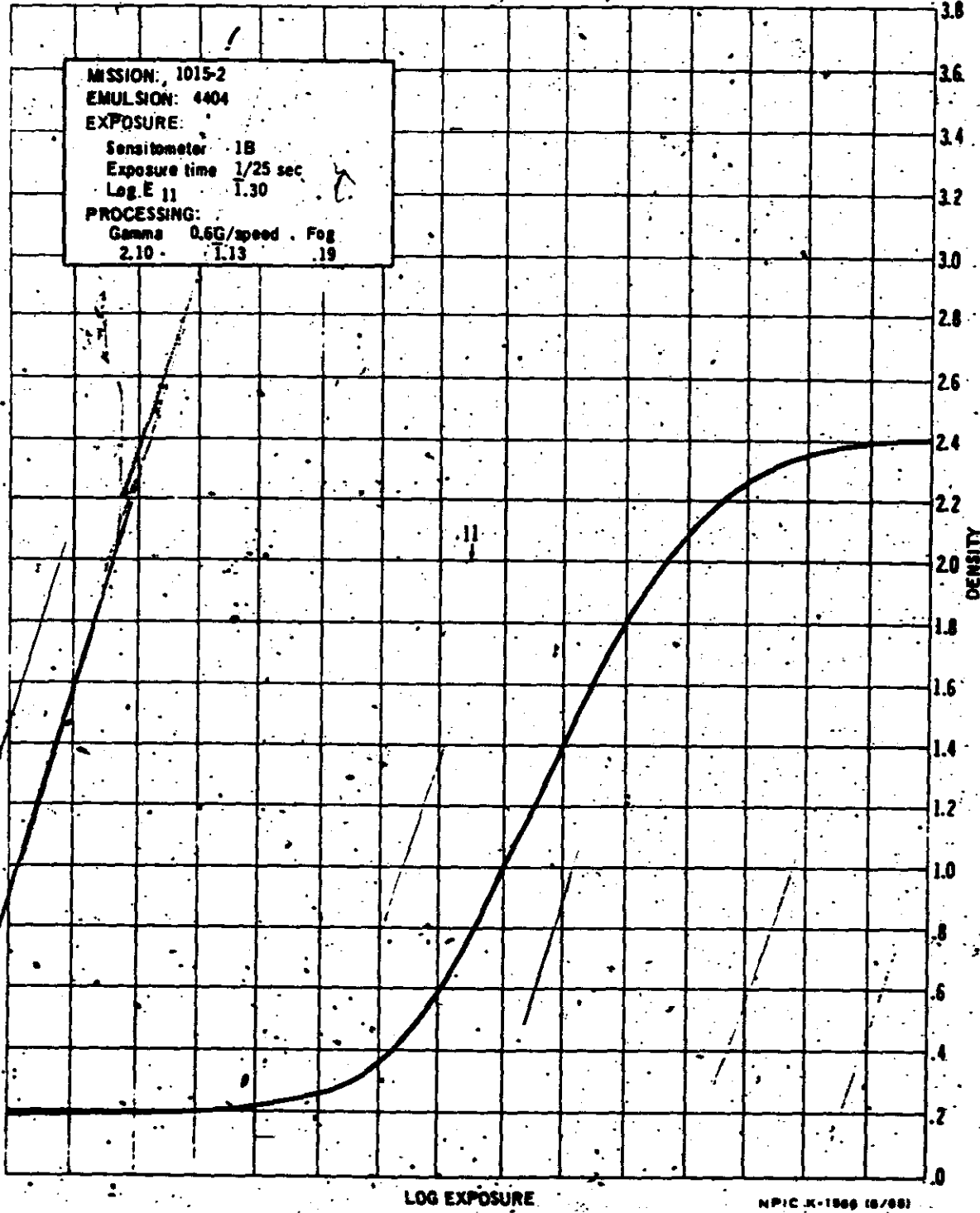

LOG EXPOSURE

NPIC X-1866 (8/68)

Handle Via
~~VALENTYKETHOLE~~
Control System Only

Handle Via
TALENT-KEYHOLE
Control System Only

SENSITOMETRIC CURVE FROM MISSION MATERIAL

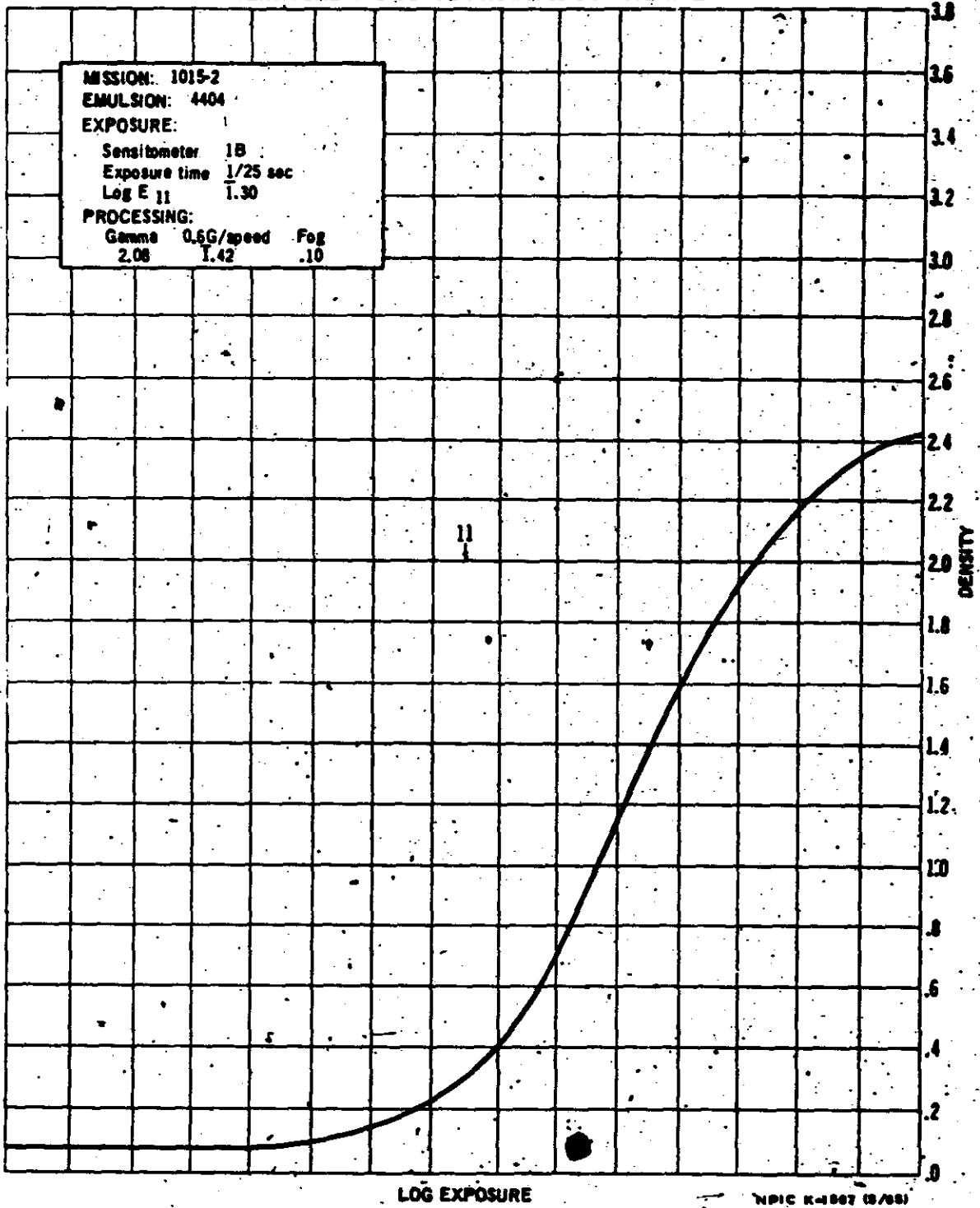

Handle Via
TALENT-KEYHOLE
Control System Only

Handle Via
~~TALENT-KEYHOLE~~
Control System Only



CONTROL CURVE FOR HEAD AND TAIL OF INDEX MATERIAL

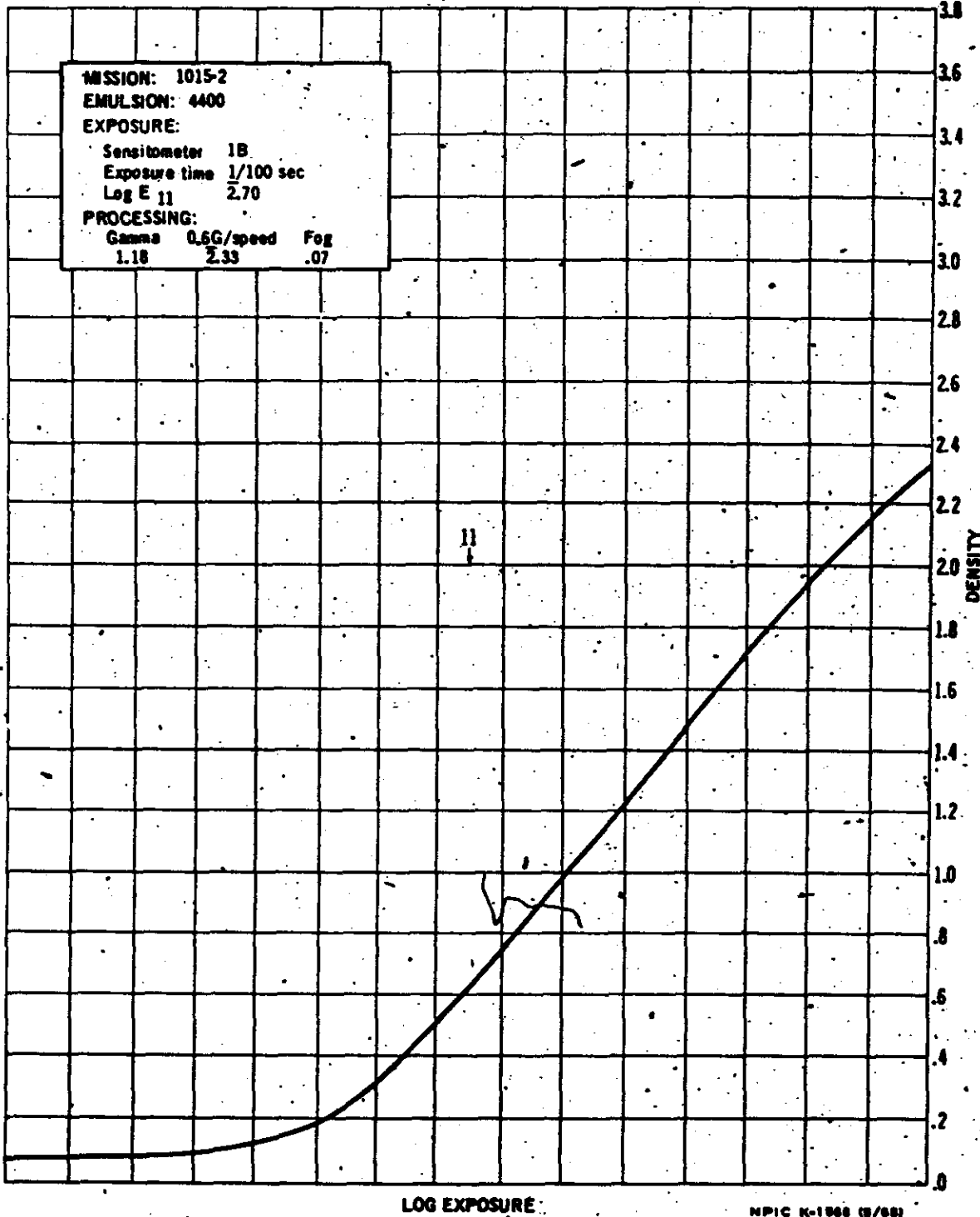

LOG EXPOSURE

NPIC K-1068 (8/68)

Handle Via
~~TALENT-KEYHOLE~~
Control System Only



PART III. IMAGE QUALITY

1. Definition of Photographic Interpretation (PI) Suitability

PI suitability is an assessment of the information content of photographic reconnaissance material and its interpretability. A number of interrelated factors are involved, such as the quality of the photography, the extent of target coverage, scale, and weather limitations. However, the fundamental criteria for assigning a PI suitability rating may be reduced to (a) the scope of the photographic coverage and (b) the degree to which a photographic interpreter may extract useful and reliable information from the material.

PI suitability ratings are: Excellent, Good, Fair, Poor, and Unusable. These ratings refer to the overall interpretive value of the photography obtained from a particular reconnaissance mission. Individual targets may also be assigned PI suitability ratings. The standards that determine assignment of the various ratings are:

Excellent: The photography is free of degradations by camera malfunctions or processing faults and weather conditions are favorable throughout. The imagery contains sharp, well defined edges and corners with no unusual distortions. Contrast is optimum and shadow details, as well as details in the highlight areas, are readily detectable. Observation of small objects and a high order of mensuration are made possible by the consistently good quality of the photography.

Good: The photography is relatively free of degradation or limiting atmospheric conditions. Edges and corners are well defined. No unusual distortions are present. Detection and accurate mensuration of small objects are feasible, but to a lesser degree than in material rated as Excellent.

Fair: Degradation is present and the acuity of the photography is less than optimum. Edges and corners are not crisply defined and there is loss of detail in shadow or highlight areas. Detection and identification of small objects are possible but accuracy of mensuration is limited by the fall-off in image quality and the less-than-optimum contrast.

Poor: Camera-induced degradations or weather limitations severely reduce the effectiveness of the photography. Definition of edges and corners are not well defined. Only gross terrain features and culture may be detected or identified and distortion of form may exist. Accurate mensuration of even large objects is doubtful.

Unusable: Degradation of photography completely precludes detection, identification, and mensuration of cultural details.

Handle Via
~~TALENT-KEYHOLE~~
Control System Only

2. PI Suitability, Missions 1015-1 and 1015-2:

The PI suitability of Mission 1015 ranges between fair and good. The photographic coverage permitted observation of 123 targets (74 in Mission 1015-1 and 49 in Mission 1015-2), but snow cover and haze conditions served to reduce the PI suitability in a number of cases.

Frame 7 of pass 26D contains an excellent example of sun-flared water and associated reflectance streaks. Although not severely degrading in many cases, reflectance streaking is an anomaly that merits attention. Basically, it derives from reflected light and is present primarily in photography containing alto cumulus cloud formations, bodies of sun-struck water, and areas of land-water adjacency, such as coastlines, peninsulas, and islands. All of the factors involved in reflectance streaking are not precisely known. It is detectable only when contrast and density permit its observation, but is undoubtedly present to some degree wherever high-reflectance conditions exist. If the streaks were associated solely with specular reflections they would be of less consequence. However, alto cumulus cloud formations also induce reflectance streaking, despite the fact that reflection of the incident light is more or less evenly distributed over a large surface and no concentrated specular reflection is observed. Similarly, streaks are occasionally noted in land-to-water transition areas, although no flare is observed. In view of the orientation of the streaks to the long axis of the film, some relation to the scan and field flattener is suspected. This possibility is currently being investigated with a view to eliminating the streaks by the employment of baffles.

A considerable number of temperature variations were experienced during flight (see Appendix D. Temperature Data) but no effects on photographic quality are detectable. However, the quality-temperature relationship, if any, will continue to be evaluated in each mission.

The following are a few of the coverage highlights reported in the PI summaries of Missions 1015-1 and 1015-2:

- (a) 2 newly identified missile complexes.
- (b) 8 newly identified missile launch sites.
- (c) 1 newly identified radar site.

Handle Via
~~TALENT-KEYHOLE~~
Control System Only

Handle Via
TALENT-KEYHOLE
Control System Only

- (d) 13 newly identified anti-aircraft artillery positions.
- (e) 1st observation of activity at a new rocket engine test facility.
- (f) 1st observation of activity in a nuclear energy test site powerplant.

The initial scan of the mission record was performed in a relatively short time, without the aid of the precise analytical and mensuration instruments normally employed in interpretation of this material. Continued study of the film may increase the number of targets observed and may alter some of the data obtained in the initial scan of the targets already reported.

Definition of Mission Information Potential (MIP) - The MIP is an arbitrary number, not limited by terminal values, which is subjectively assigned to the panoramic photography of a mission and which compares it to the other missions. It is meant to be a measure of the camera's maximum capability for recording information, discounting adverse atmospheric conditions, minimum solar elevations, camera malfunctions, or other factors which reduce the quality of the photography.

The MIP is based on the best photography found in a mission, even though the photography may be limited to a few frames. Since these frames are considered to be the best in the mission, they do not indicate the overall success, average quality, or general interpretability of the photography.

Criteria for selection of the MIP frame:

- a. Eliminate all portions of the mission affected by system malfunctions.
- b. Select frames which are free of clouds or atmospheric attenuation.
- c. Eliminate the first 10 frames and last frame of a pass because these may be affected by incorrect scan speed.
- d. Select frames that are in a continuous strip of approximately 10 cloud-free frames because cloud shadows from weather fronts are cast for great distances.
- e. Determine from the horizon cameras that the panoramic photography is not affected by apparent vehicle perturbations.
- f. Select targets that are near the center of the format and on frames as close as possible to perigee for scale purposes and to eliminate obliquity.
- g. Select frames having near optimum solar elevation.
- h. Select a high-contrast target (preferably an airfield) and compare the target to a previous mission which has been given an MIP rating.

Handle Via
TALENT-KEYHOLE
Control System Only

~~TOP SECRET RUFF~~

~~NO FOREIGN DISSEM~~

Handle Via
~~TALENT KEYHOLE~~
Control System Only.

4. MIP, Missions 1015-1 and 1015-2:

Based on the foregoing criteria, an airfield in frame 14 of pass 47DE AFT and a port facility in frame 24 of pass 88D AFT are selected as the MIP examples for Missions 1015-1 and 1015-2, respectively. Mission 1015 is assigned an MIP rating of 85 and the photographic quality is comparable to that achieved in Mission 1012, 17-23 October 1964. The photography obtained from the slave (AFT) camera is slightly superior to the master (FWD) material.

- 26 -

Handle Via
~~TALENT KEYHOLE~~
Control System Only

~~TOP SECRET RUFF~~

~~NO FOREIGN DISSEM~~

Handle Via
~~TALENT KEYHOLE~~
Control System Only



FIGURE 7. MIP SELECTION, MISSION 1015-1.

NPIC K-1800 (8/88)

Handle Via
~~TALENT KEYHOLE~~
Control System Only

Handle Via
~~TALENT-KEYHOLE~~
Control System Only



Camera	AFT
Pass	47DE
Frame	14
Date of Photography	22 December 1964
Universal Grid Coordinates	65.5-11.0
Enlargement Factor	20X
Geographic Coordinates	36-16N 114-29W
Altitude (feet)	601,989
Camera Altitude		
Pitch	Not Available
Roll	Not Available
Yaw	Not Available
Local Sun Time	1231 Hours
Solar Elevation	29°51'
Solar Azimuth	172°
Exposure	1/477 Sec

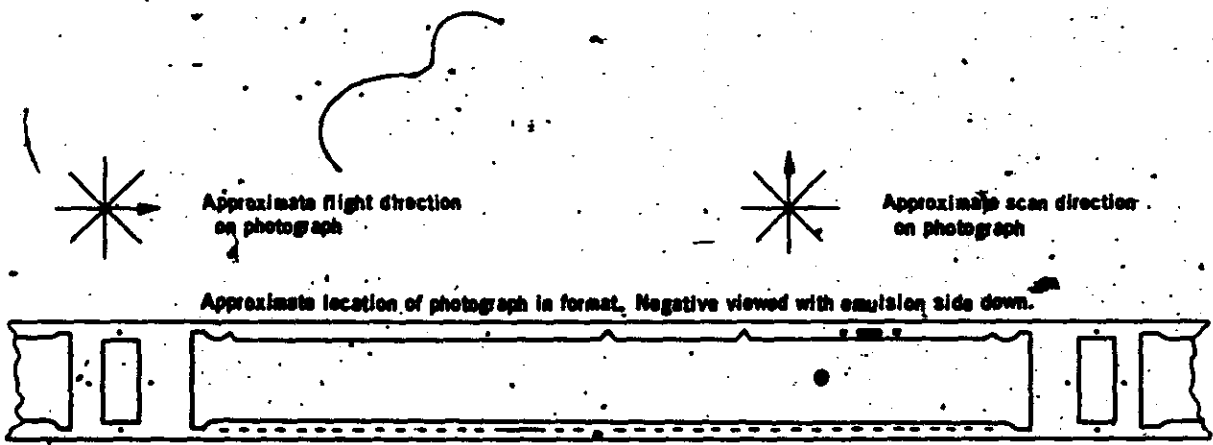

Handle Via
~~TALENT-KEYHOLE~~
Control System Only

~~TOP SECRET - RUFF~~
ALL INFORMATION CONTAINED HEREIN IS UNCLASSIFIED EXCEPT WHERE SHOWN OTHERWISE

Handle Via
~~TALENT-KEYHOLE~~
Control System Only

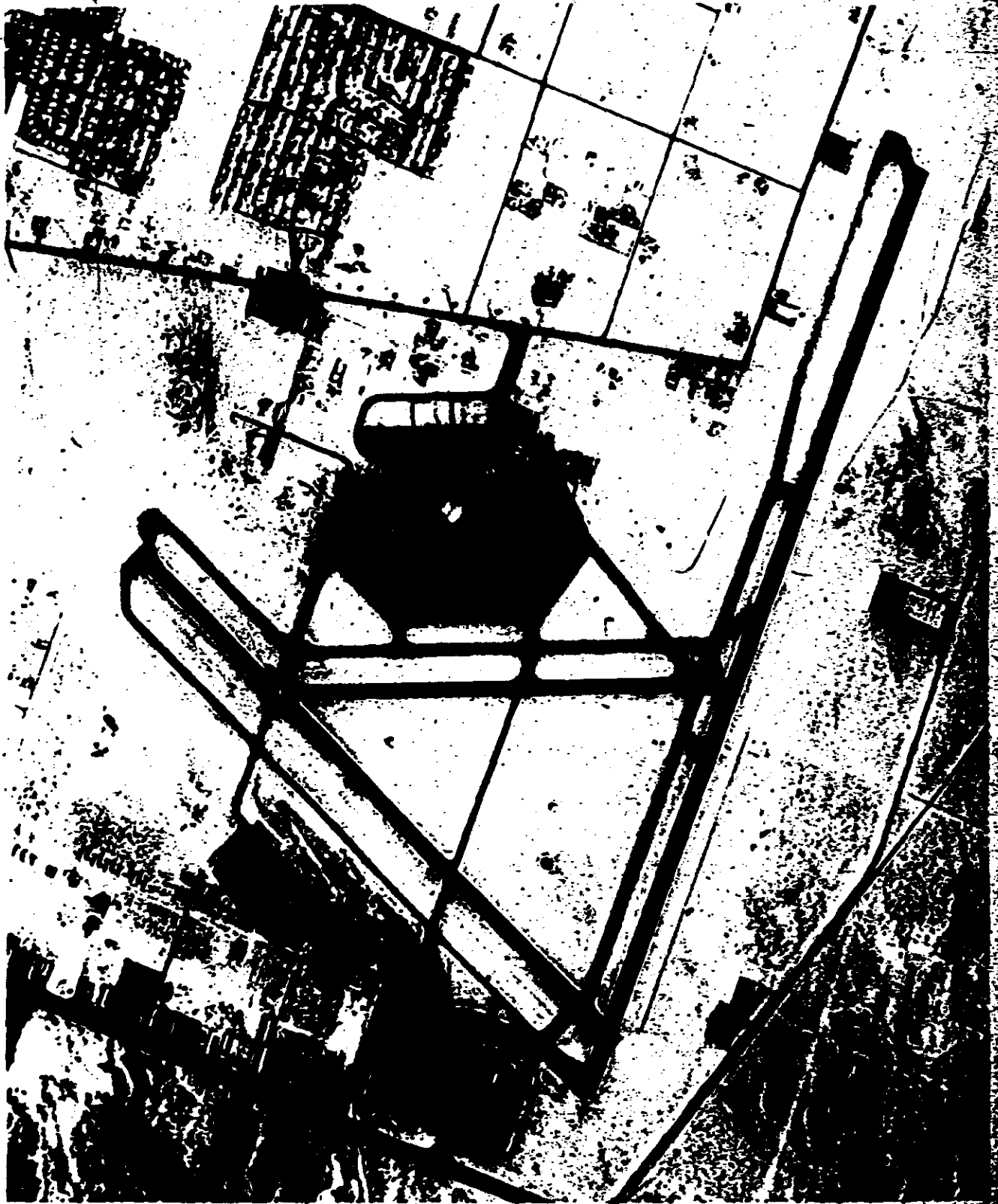

Handle Via
~~TALENT-KEYHOLE~~
Control System Only

~~TOP SECRET - RUFF~~
ALL INFORMATION CONTAINED HEREIN IS UNCLASSIFIED EXCEPT WHERE SHOWN OTHERWISE

~~TOP SECRET RUFF~~

~~NO FOREIGN DISSEM~~

Handle Via
~~TALENT-KEYHOLE~~
Control System Only



FIGURE 8. MIP SELECTION, MISSION 1015-2.

NPIC K-1870 (8/88)

Handle Via
~~TALENT-KEYHOLE~~
Control System Only

~~TOP SECRET RUFF~~

~~NO FOREIGN DISSEM~~

Handle Via
~~TALENT KEYHOLE~~
Control System Only



Camera	AFT
Pass	88D
Frame	24
Date of Photography	25 December 1964
Universal Grid Coordinates	31,0-11.5
Enlargement Factor	20X
Geographic Coordinates	Not Available
Altitude (feet)	Not Available
Camera Altitude	
Pitch	Not Available
Roll	Not Available
Yaw	Not Available
Local Sun Time	Not Available
Solar Elevation	Not Available
Solar Azimuth	Not Available
Exposure	Not Available



Approximate flight direction
on photograph



Approximate scan direction
on photograph

Approximate location of photograph in format. Negative viewed with emulsion side down.



Handle Via
~~TALENT KEYHOLE~~
Control System Only

~~TOP SECRET - RUFF~~
~~NO FORN DISSEM~~

Handle Via
~~TALINT-KEYHOLE~~
Control System Only



~~TOP SECRET - RUFF~~
~~NO FORN DISSEM~~

Handle Via
~~TALINT-KEYHOLE~~
Control System Only

~~TOP SECRET RUFF~~

~~NO FOREIGN DISSEM~~

Handle Via
~~TALENT-KEYHOLE~~
Control System Only



FIGURE 9. EXAMPLE OF MASTER (FWD) PANORAMIC CAMERA PHOTOGRAPHIC QUALITY.

NPIC K-1871 (8/88)

- 26e -

Handle Via
~~TALENT-KEYHOLE~~
Control System Only

~~TOP SECRET RUFF~~

~~NO FOREIGN DISSEM~~

Handle Via
~~TALENT-KEYHOLE~~
Control System Only



Camera	FWD
Pass	47DE
Frame	9
Date of Photography	22 December 1964
Universal Grid Coordinates	30-13
Enlargement Factor	20X
Geographic Coordinates	36-23N 114-28W
Altitude (feet)	603,816
Camera Altitude	
Pitch	15°40'
Roll	-00°23'
Yaw	00°16'
Local Sun Time	1233 Hours
Solar Elevation	29°44'
Solar Azimuth	171°
Exposure	1/675 Sec



Approximate flight direction
on photograph



Approximate scan direction
on photograph

Approximate location of photograph in format. Negative viewed with emulsion side down.

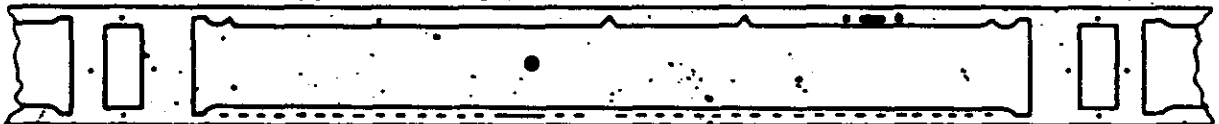

Handle Via
~~TALENT-KEYHOLE~~
Control System Only

~~TOP SECRET - RUFF~~
~~NO FOREIGN DISSEM~~

Handle Via
~~TALENT KEYHOLE~~
Control System Only



Handle Via
~~TALENT KEYHOLE~~
Control System Only

~~TOP SECRET - RUFF~~
~~NO FOREIGN DISSEM~~

~~TOP SECRET RUFF~~

~~NO FOREIGN DISSEM~~

Handle Via
TALENT-KEYHOLE
Control System Only



FIGURE 10. EXAMPLE OF SLAVE (AFT) PANORAMIC CAMERA PHOTOGRAPHIC QUALITY.

NPIC K-1872 (8/88)

- 26g -

Handle Via
TALENT-KEYHOLE
Control System Only

~~TOP SECRET RUFF~~

~~NO FOREIGN DISSEM~~

Handle Via
~~TALENT-KEYHOLE~~
Control System Only



Camera	AFT
Pass	47DE
Frame	13
Date of Photography	22 December 1964
Universal Grid Coordinates	61.5-13.5
Enlargement Factor	20X
Geographic Coordinates	36-25N 114-32W
Altitude (feet)	602,267
Camera Attitude		
Pitch	Not Available
Roll	Not Available
Yaw	Not Available
Local Sun Time	1231 Hours
Solar Elevation	29°42'
Solar Azimuth	172°
Exposure	1/477 Sec



Approximate flight direction
on photograph



Approximate scan direction
on photograph

Approximate location of photograph in format. Negative viewed with emulsion side down.

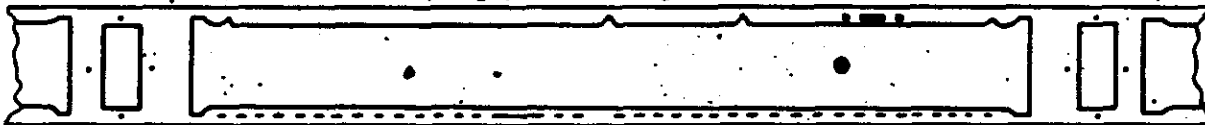

Handle Via
~~TALENT-KEYHOLE~~
Control System Only

~~TOP SECRET - RUFF~~

~~NO FOREIGN DISSEM~~

Handle Via
~~TALENT-KEYHOLE~~
Control System Only



Handle Via
~~TALENT-KEYHOLE~~
Control System Only

~~TOP SECRET - RUFF~~

~~NO FOREIGN DISSEM~~

Handle Via
~~TALENT KEYHOLE~~
Control System Only



FIGURE 11. FIXED RESOLUTION TARGET, INDIAN SPRINGS, NEVADA.

NPIC K-1878 (8/68)

Handle Via
~~TALENT KEYHOLE~~
Control System Only

~~TOP SECRET RUFF~~

~~NO FOREIGN DISSEM~~

Handle Via
~~TALENT KEYHOLE~~
Control System Only



Camera	FWD
Pass	47DE
Frame	5
Date of Photography	22 December 1964
Universal Grid Coordinates	23.5-10.5
Enlargement Factor	40X
Geographic Coordinates	36-59N 114-41W
Altitude (feet)	605,024
Camera Attitude	
Pitch	15°34'
Roll	-00°23'
Yaw	00°19'
Local Sun Time	1232 Hours
Solar Elevation	29°10'
Solar Azimuth	171°
Exposure	1/680 Sec



Approximate flight direction
on photograph



Approximate scan direction
on photograph

Approximate location of photograph in format. Negative viewed with emulsion side down.

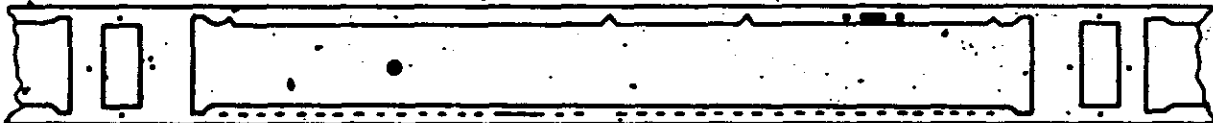

Handle Via
~~TALENT KEYHOLE~~
Control System Only

~~TOP SECRET RUFF~~

~~NO FOREIGN DISSEM~~

TOP SECRET - RUFF
NO FOREIGN DISSEM

Handle Via
TALENT REVIHOLE
Control System Only

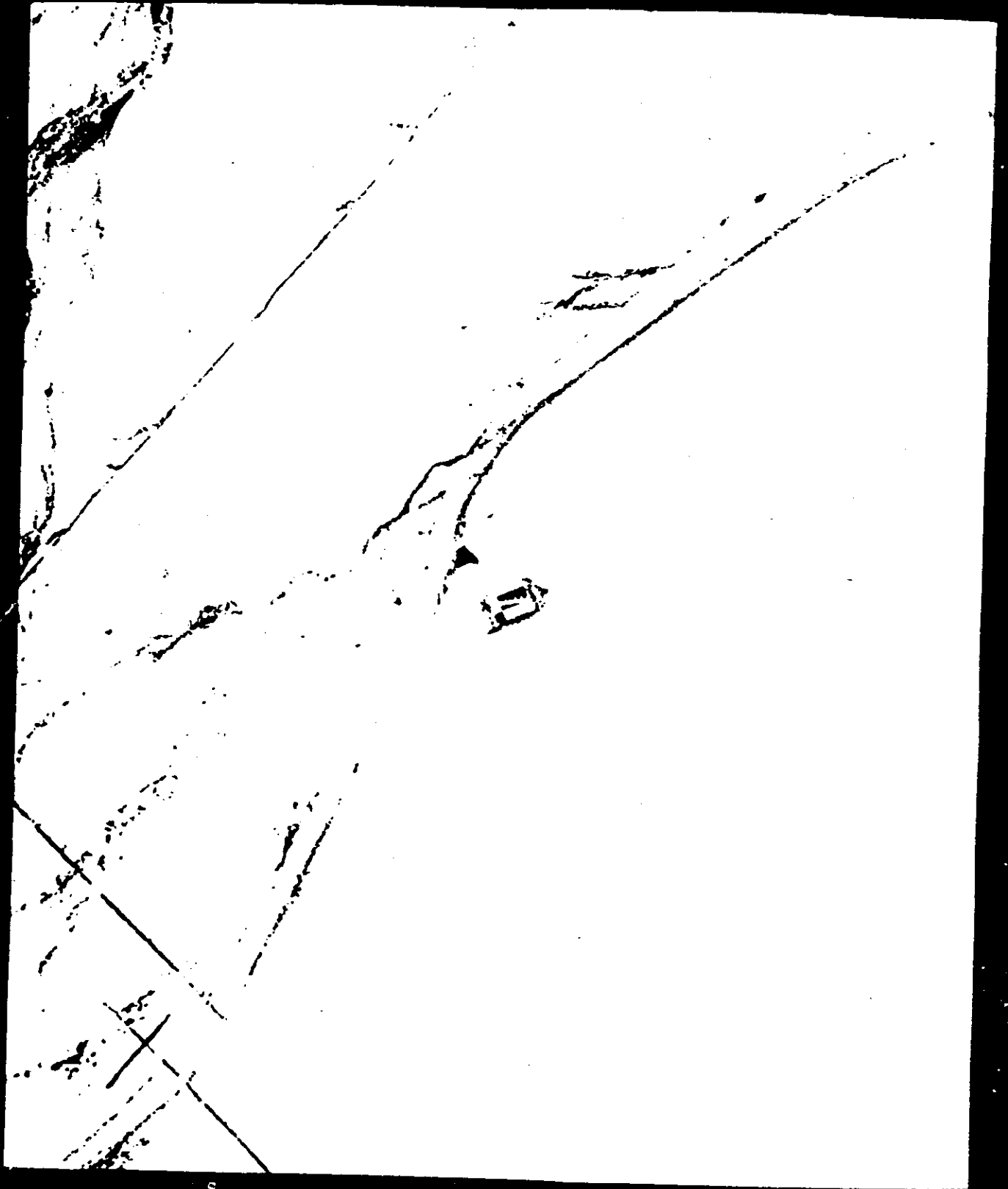

TOP SECRET - RUFF
NO FOREIGN DISSEM

Handle Via
TALENT REVIHOLE
Control System Only

Handle Via
~~TALENT KEYHOLE~~
Control System Only

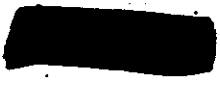

FIGURE 12. EXAMPLE OF SUN-FLARED WATER AND ASSOCIATED STREAKS.

NPIC, K-1074 (8/68)

Handle Via
~~TALENT KEYHOLE~~
Control System Only

Handle Via
TALENT-KEYMOLE
Control System Only



Camera	FWD
Pass	26B
Frame	7
Date of Photography	21 December 1964
Universal Grid Coordinates	19-11 (Center)
Enlargement Factor	2X
Geographic Coordinates	04-49S 014-51E
Altitude (feet)	636,679'
Camera Attitude		
Pitch	14°30'
Roll	00°06'
Yaw	00°38'
Local Sun Time	1337 Hours
Solar Elevation	59°43'
Solar Azimuth	50°
Exposure	1/640 Sec



Approximate flight direction
on photograph



Approximate scan direction
on photograph

Approximate location of photograph in format. Negative viewed with emulsion side down.



Handle Via
TALENT-KEYMOLE
Control System Only

~~TOP SECRET - RUFF~~
~~NO FOREIGN DISSEM~~

Handle Via
~~TALENT KEYHOLE~~
Control System Only

TCS-8-356/65



~~TOP SECRET - RUFF~~
~~NO FOREIGN DISSEM~~

Handle Via
~~TALENT KEYHOLE~~
Control System Only

Handle Via
~~TALENT KEYHOLE~~
Control System Only

APPENDIX A. SYSTEM SPECIFICATIONS

1. Cameras:

PANORAMIC CAMERAS	MASTER (FWD)	SLAVE (AFT)
Camera Number	138	141
Lens Serial Number	1152435	1182435
Slit Width	0.250"	0.175"
Aperture	f/3.5	f/3.5
Filter	Wratten 25	Wratten 21
Operational F/L	609.602 mm	609.617 mm
Film Type	7J-40	7J-40
Film Length	16,000 ft	16,000 ft
Splices	4	4
Emulsion	68-6-7-4	68-6-7-4
Static Bench Test:		
High Contrast	300 L/mm	258 L/mm
Low Contrast	140 L/mm	158 L/mm
Dynamic Test:		
ITEK High Contrast	164 L/mm	165 L/mm
ITEK Low Contrast	120 L/mm	130 L/mm
AP High Contrast	185 L/mm	189 L/mm
AP Low Contrast	117 L/mm	121 L/mm

Handle Via
~~TALENT KEYHOLE~~
Control System Only

Handle Via
~~TALENT KEYHOLE~~
Control System Only



STELLAR/INDEX CAMERAS	STELLAR		INDEX	
	1015-1	1015-2	1015-1	1015-2
Camera Number	61	58	D61	D58
Lens Serial Number	10516	10631	817016	813068
Reseau Serial Number	61	58	61	58
Filter	None	None	Wratten 21	Wratten 21
Aperture	f/1.8	f/1.8	f/4.5	f/4.5
Exposure Time	2 sec	2 sec	1/500 sec	1/500 sec
Operational F/L	Not	Not		
Film Type	Applicable	Applicable	38.02 mm	38.334 mm
Film Length	3J-34	3J-34	7J-33	7J-33
	Not	Not	Not	Not
	Reported	Reported	Reported	Reported
Perpendicularity of Reseau to Optical Axis	.0007/.937"	.0006/.937"	.0002/2.25"	.0003/2.25"
Location of Principal Point	Not	Not	Not	Not
	Reported	Reported	Reported	Reported

HORIZON CAMERAS	MASTER		SLAVE	
	Stbd (Take-up)	Port (Supply)	Stbd (Supply)	Port (Take-up)
Camera Number	138	138	141	141
Lens Serial Number	813525	813558	813534	813526
Exposure Time	1/100 sec	1/100 sec	1/100 sec	1/100 sec
Aperture	f/8.0	f/6.8	f/8.0	f/6.8
Filter	Wratten 25	Wratten 25	Wratten 25	Wratten 25
Operational F/L	54.93 mm	54.89 mm	54.80 mm	54.93 mm
Average L/MM	114 L/mm	94 L/mm	106 L/mm	111 L/mm
Radial Distortion:				
10° Off-Axis	0.001 mm	0.001 mm	0.004 mm	0.009 mm
20° Off-Axis	0.002 mm	0.001 mm	0.004 mm	0.015 mm
Tangential Distortion	0.004 mm	0.001 mm	0.007 mm	0.009 mm

Handle Via
~~TALENT KEYHOLE~~
Control System Only

Handle Via
~~TALENT KEYHOLE~~
Control System Only



MASTER (FWD) HORIZON CAMERAS

RESOLUTION	Starboard (Take-Up)							Port (Supply)					
Angle Off-Axis	0	5	10	15	20	25	27.5	0	10	15	20	25	30
Radial Resolution	164	155	136	106	87	112	91	170	111	87	75	97	63
Tangential Resolution	164	145	127	102	91	60	51	170	98	89	66	58	42

SLAVE (AFT) HORIZON CAMERAS

RESOLUTION	Starboard (Supply)							Port (Take-Up)					
Angle Off-Axis	0	5	10	15	20	25	27.5	0	10	15	20	25	27.5
Radial Resolution	164	145	114	99	97	111	103	170	148	101	95	97	75
Tangential Resolution	164	145	112	102	91	60	51	170	138	100	80	55	42

Handle Via
~~TALENT KEYHOLE~~
Control System Only

~~TOP SECRET RUFF~~

NO FOREIGN DISSEM

TALENT-KEYHOLE
Control System Only

VEHICLE LAYOUT

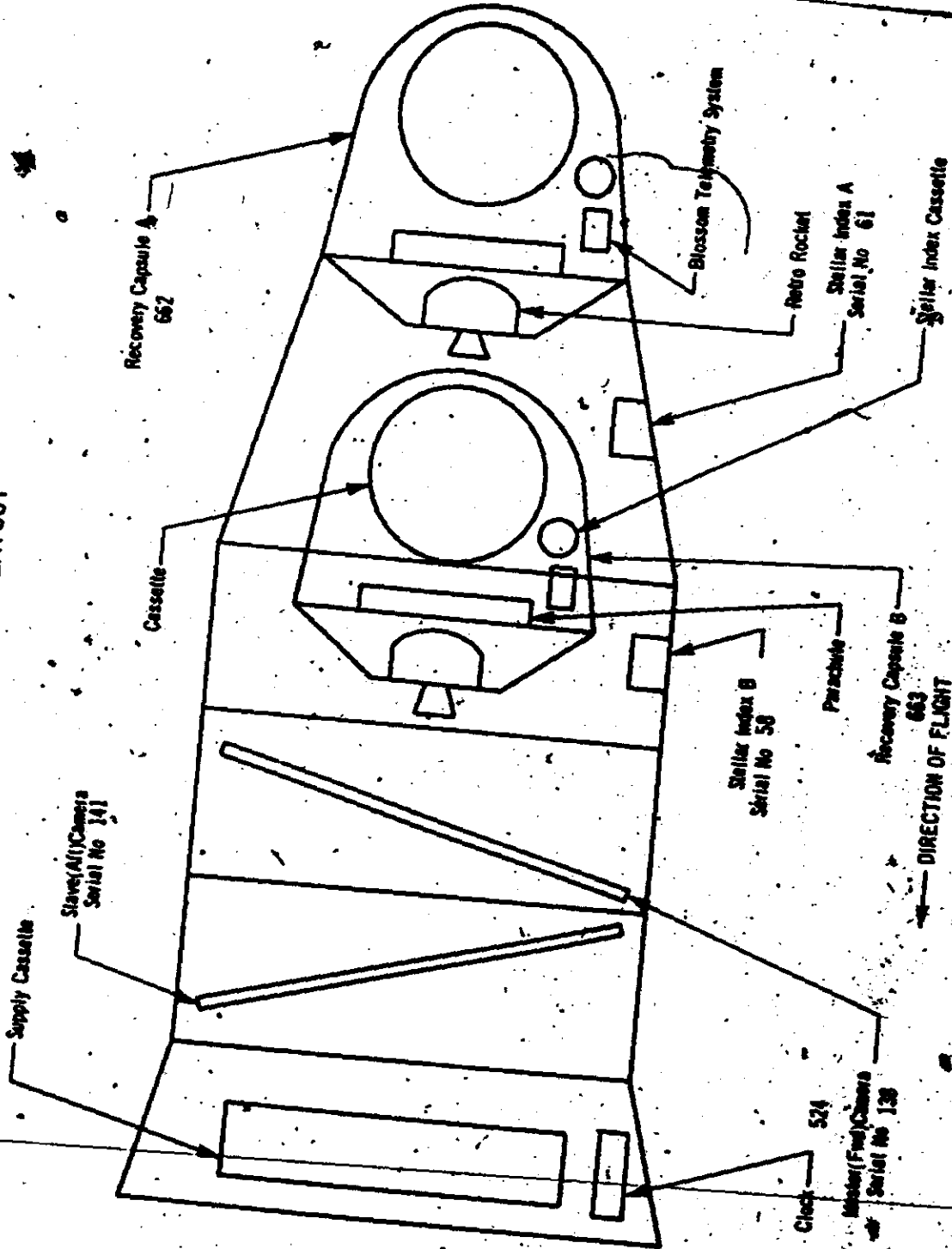

NPIC R-1876 10/681

~~TOP SECRET RUFF~~

NO FOREIGN DISSEM

Handle Via
~~TALENT-KEYHOLE~~
Control System Only

Handle Via
TALENT-KEYHOLE
Control System Only

FILM SPECIFICATIONS
FORMAT LAYOUT

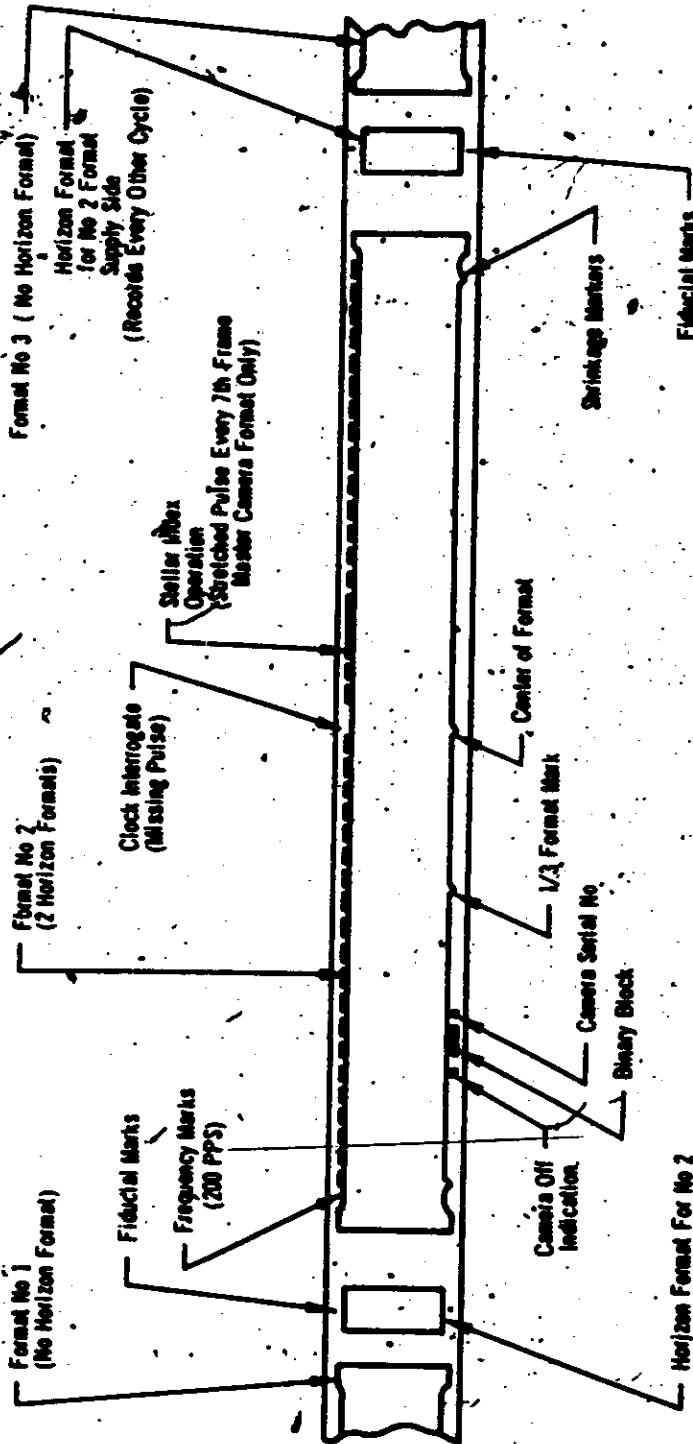

Master (Fwd) Panoramic Camera No 138
 Viewed With Negative Emission Down
 Direction of Film Transport ←
 Direction of Scan →
 Direction of Vehicle Motion ↑

Slave (AR) Panoramic Camera No 141
 Viewed With Negative Emission Down
 Direction of Film Transport ←
 Direction of Scan →
 Direction of Vehicle Motion ↑

NPIC N-1077 (9/68)

Handle Via
TALENT-KEYHOLE
Control System Only

Handle Via
~~TALENT-KEYHOLE~~
Control System Only

4. DEFINITION OF PANORAMIC CAMERA FORMAT CALIBRATIONS:

Measurements are made with respect to collimator targets fixed with respect to the mechanical interface between the total payload assembly and the orbital vehicle.

Two sets, of 3 targets each, are aligned to be coplanar within ± 5 seconds of arc so positioned as to form an angle of -15.00 degrees ± 5 seconds to the mechanical interface for master camera calibrations and an angle of $+15.00$ degrees ± 5 seconds to the mechanical interface for slave camera calibrations.

A. Target 1 of each set is imaged on the terrain format.

B. The second and third targets of each set are at angles of 75.00 degrees ± 5 seconds from target 1 and are imaged on the horizon formats.

The indicated center of format for the panoramic cameras is given by the intersection of a line through the center of mass of the central shrinkage marker drawn normal to the edge of format containing the shrinkage marker and a line parallel to the same edge located at a position half-way between the format edges.

The indicated principal points of the horizon cameras are the points of intersection of lines joining opposite fiducials.

X₀ and Y₀ are the offsets of target 1 from the indicated center of format of the panoramic cameras as defined in Paragraph 3.

X_s, Y_s and X_t, Y_t are the offsets of targets 2 and 3 from the indicated principal points of the supply and take-up horizon cameras respectively.

The indicated flight direction is the direction of vehicle travel during orbit. The forward edge of format is the edge opposite the shrinkage markers for the slave camera.

Dimensions A, B, and C are the spacings of the shrinkage markers, and dimensions D and E are the spacings of the Y axis fiducials. Techniques for exact measurement of these dimensions have not been developed. The figures quoted are measurements made on hand-processed film without control of shrinkage.

The format dimensions are measured to the best estimate of format edge.

Handle Via
~~TALENT-KEYHOLE~~
Control System Only

~~TOP SECRET RUFF~~

~~NO FOREIGN DISSEM~~

Handle Via
~~TALENT KEYHOLE~~
Control System Only

Measurement of the angle between the indicated axis of the panoramic cameras and the line of intersection of the plane defined in Paragraph 2 on the format is obtained from the offset dimensions D_{ux} and D_{uy} of target-1 for each camera.

Measurement of the angle between the indicated axis of the horizon cameras and the line of intersection of the plane defined in Paragraph 2 on the format is made by measuring the scan direction offset of the targets defined in Paragraph 2B at a fixed distance from the target center in the Y direction. Dimensions D_{tx} , D_{ty} , D_{sx} , and D_{sy} are the offsets of these measurements.

Handle Via
~~TALENT KEYHOLE~~
Control System Only

~~TOP SECRET RUFF~~

~~NO FOREIGN DISSEM~~

Handle Via
~~TALENT-KEYHOLE~~
 Control System Only

~~TOP SECRET RUFF~~
~~NO FOREIGN DISSEM~~

FILM SPECIFICATIONS
 FORMAT DIMENSIONS

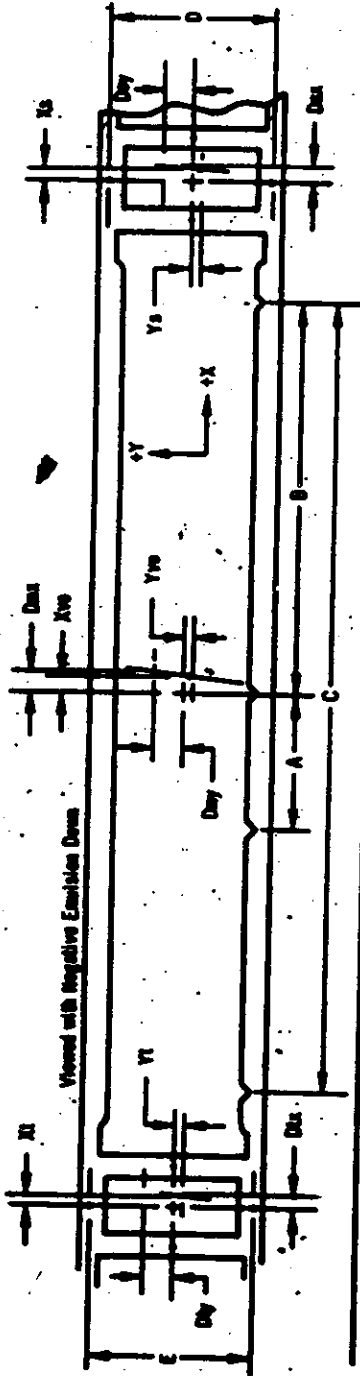

Instel/Pan Camera No 138	Vehicle Motion	Scan Direction	Steno/ANOC Camera No 141	Vehicle Motion	Scan Direction
A 75.1	Xi -0.020	Dx -0.028	A 75.2	Xi -0.185	Dx -0.191
B 355.1	Yi 0.155	Dy 2.873	B 354.8	Yi -0.203	Dy 1.762
C 710.2	Xs 0.222	Ds 0.224	C 710.0	Xs -0.171	Ds -0.180
D 56.640	Ys 0.121	Dy 2.375	D 56.454	Ys -0.091	Dy -2.097
E 75.432	Xyo 1.008	Ds 0.551	E 56.448	Xyo -1.014	Ds -1.003
	Yyo	Dy -4.005		Yyo 0.167	Dy 3.167

Format dimensions:

Panamic

Height 57.965
 Width 753.50

- NOTE: 1. All dimensions are in millimeters and are average dimensions of three formats
 2. Height of main format is taken at center of format
 3. Dx, Dy, Ds, X and Y dimensions are taken 10 mm above point defining target center
 4. Format Sign Convention

$$\begin{array}{c} -X+Y \\ -X-Y \\ +X+Y \\ +X-Y \end{array}$$

MPIC N-1878 (8/68)

~~TOP SECRET RUFF~~
~~NO FOREIGN DISSEM~~

Handle Via
~~TALENT-KEYHOLE~~
 Control System Only

Handle Via
~~TALENT-KEYHOLE~~
Control System Only

~~TOP SECRET RUFF~~
NO FOREIGN DISSEM

HORIZON LENS SETTINGS
(Viewed from top of vehicle in flight)

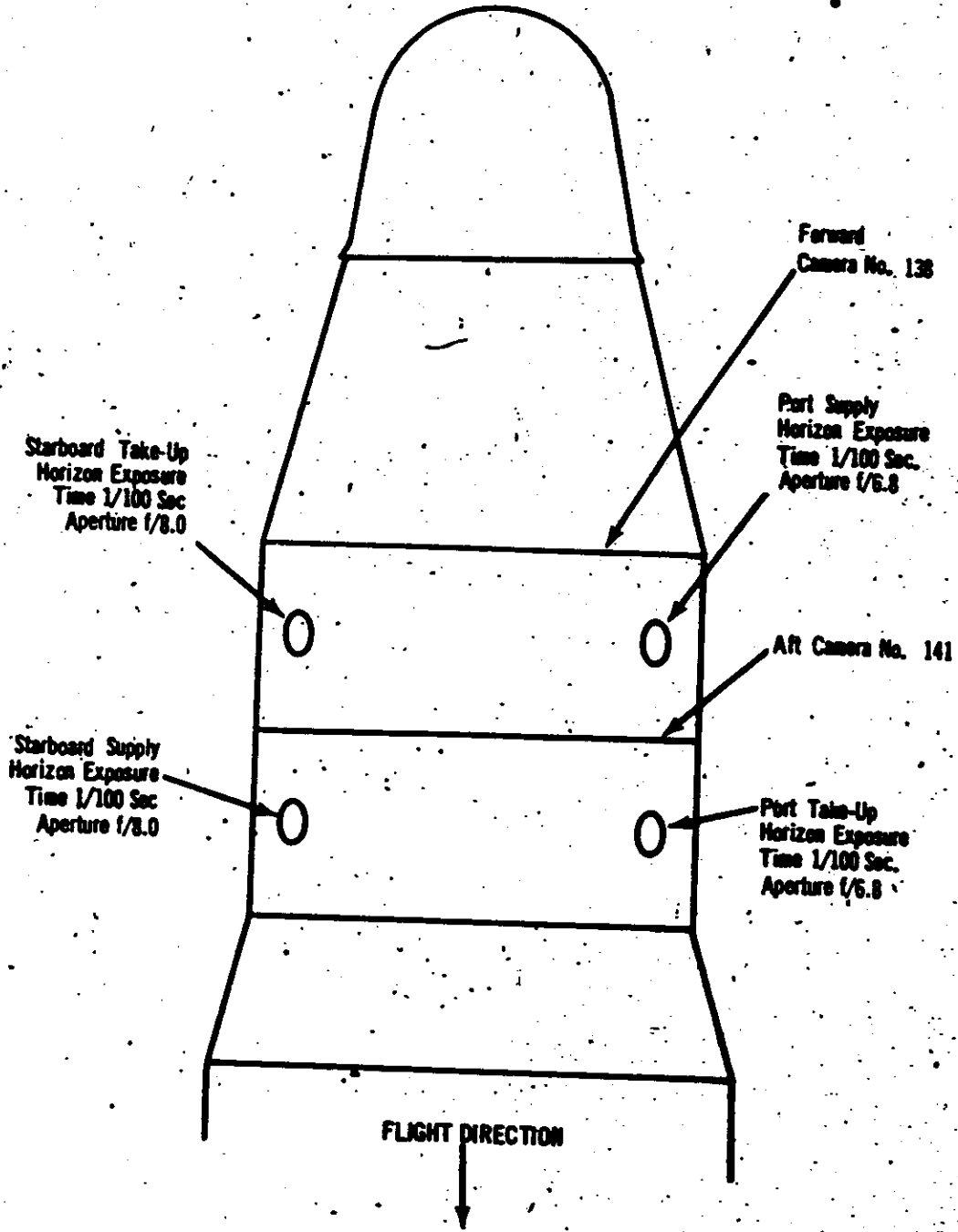

~~TOP SECRET RUFF~~
NO FOREIGN DISSEM

Handle Via
~~TALENT-KEYHOLE~~
Control System Only

APPENDIX B. DENSITY READINGS
Mission 1015-1

Pass	Frame	STELLAR CAMERA					INDEX CAMERA					TERRAIN		
		Dmax	Dmin	Delta	Gross Fog	LIMITING			Gross Fog	Dmax	Dmin	Delta		
						Dmax	Dmin	Delta						
1D	1	1.12	0.32	0.80	0.20	.72	.14	.58	.09	NR	NR	.44	NR	.44
3D	3	1.58	0.35	1.23	0.20	.72	.28	.44	.10	.72	.28	.28	.28	.44
4D	4	1.54	0.40	1.14	0.21	.72	.20	.52	.09	.72	.28	.28	.28	.44
6D	6	1.64	0.49	1.15	0.20	.64	.15	.49	.09	NR	NR	.18	NR	.29
7D	7	1.03	0.33	0.70	0.20	.47	.18	.29	.09	.47	.18	.18	.18	.29
21D	21	1.98	0.50	1.48	0.19	1.08	.28	.80	.08	1.08	.08	.42	.42	.66
22D	22	2.17	0.31	0.92	0.19	.44	.17	.27	.09	.30	.19	.19	.19	.11
37D	37	1.60	0.56	1.61	0.20	1.06	.21	.85	.09	NR	NR	.25	NR	.50
38D	38	2.16	0.42	1.22	0.19	.95	.18	.77	.09	NR	NR	.15	NR	.25
61D	61	2.01	0.62	1.54	0.19	1.14	.25	.89	.09	.75	.25	.15	.15	.25
62D	62	1.01	0.28	0.73	0.19	.40	.15	.40	.09	.40	.15	.15	.15	.25
76D	76	2.50	0.72	1.78	0.21	1.24	.32	.92	.09	1.24	.32	.32	.32	.92
99A	77	NR	NR	NR	0.20	NR	NR	NR	.09	NR	NR	NR	NR	NR
100D	78	2.15	0.58	1.57	0.21	.60	.38	.22	.09	.60	.38	.38	.38	.22
88D	88	2.58	0.84	1.74	0.21	1.39	.42	.97	.09	NR	NR	.40	NR	.18
89D	89	2.62	0.79	1.83	0.21	1.30	.20	1.10	.09	.58	.40	.40	.40	.18
92D	92	2.38	0.74	1.64	0.21	.98	.14	.84	.09	.56	.18	.18	.18	.38
93D	93	2.40	0.72	1.68	0.21	1.14	.16	.95	.09	.56	.18	.18	.18	.38
94D	94	2.46	0.76	1.70	0.21	1.20	.22	.98	.09	.40	.40	.40	.40	.26
95D	95	1.85	0.32	0.93	0.21	.40	.14	.26	.09	NR	NR	.14	NR	.26
104D	104	1.88	0.51	1.37	0.21	1.40	.18	.82	.09	.40	.40	.18	.18	.82
105D	105	1.63	0.42	1.21	0.19	.98	.16	.82	.09	1.00	.18	.18	.18	.82
120D	120	1.99	0.54	1.45	0.20	1.27	.15	.82	.09	.73	.40	.40	.40	.33
121D	121	1.40	0.35	1.05	0.20	.70	.18	.52	.09	NR	NR	.30	NR	.40
136D	136	2.14	0.51	1.63	0.20	1.58	.19	1.39	.09	.70	.30	.30	.30	.40
137D	137	1.22	0.32	0.90	0.20	.48	.10	.38	.09	.52	.28	.28	.28	.24
147D	147	2.48	0.72	1.76	0.20	1.08	.21	.87	.09	.48	.10	.10	.10	.38
148D	148	2.49	0.69	1.80	0.20	1.08	.29	.87	.09	1.00	.38	.38	.38	.62
150D	150	2.53	0.79	1.74	0.20	1.73	.29	1.44	.09	.64	.50	.50	.50	.14
151D	151	2.46	0.80	1.66	0.21	1.72	.28	1.44	.09	NR	NR	.50	NR	.14
158D	158	2.20	0.62	1.58	0.21	1.22	.21	1.01	.09	NR	NR	.50	NR	.14
311D	159	2.34	0.59	1.75	0.21	1.34	.18	1.16	.09	NR	NR	.50	NR	.14
162D	162	2.38	0.69	1.69	0.21	1.50	.21	1.29	.09	NR	NR	.50	NR	.14
163D	163	1.19	0.35	0.84	0.21	1.25	.15	1.10	.09	1.34	.21	.21	.21	1.13
168D	168	2.05	0.61	1.44	0.21	.42	.20	.22	.09	.61	.30	.30	.30	.31
169D	169	1.76	0.49	1.27	0.21	1.36	.22	1.14	.09	.42	.20	.20	.20	.22
177D	177	2.00	0.51	1.49	0.20	.68	.26	.42	.09	NR	NR	.26	NR	.42
						.91	.21	.70	.09	NR	NR	.26	NR	.42

NR - Denotes No Reading Made

Handle Via
TALENT KEYHOLE
Control System Only

~~TOP SECRET RUFF~~
~~NO FOREIGN DISSEM~~

Mission 1019-1

Pass	STELLAR CAMERA										INDEX CAMERA										
	LIMITING					GROSS FOG					LIMITING					GROSS FOG					
	Dmax	Dmin	Delta	Dmax	Dmin	Delta	Dmax	Dmin	Delta	Dmax	Dmin	Delta	Dmax	Dmin	Delta	Dmax	Dmin	Delta	Dmax	Dmin	Delta
37D	1.81	0.42	1.39	0.19	0.19	0.20	.78	.20	.58	.09	.66	.20	.46	.46	NR	NR	NR	NR	NR	NR	NR
38D	2.15	0.58	1.57	0.20	0.20	0.20	1.32	.14	1.18	.09	.70	.19	.19	.19	NR	NR	NR	NR	NR	NR	NR
39D	1.64	0.49	1.15	0.20	0.20	0.20	.70	.19	.51	.08	.70	.19	.19	.19	NR	NR	NR	NR	NR	NR	NR
41D	2.65	0.72	1.93	0.20	0.20	0.20	1.55	.28	1.27	.08	.62	.43	.43	.43	NR	NR	NR	NR	NR	NR	NR
47DE	1.22	0.30	0.92	0.21	0.21	0.21	.36	.13	.25	.09	.38	.13	.13	.13	NR	NR	NR	NR	NR	NR	NR
52D	2.50	0.72	1.78	0.21	0.21	0.21	1.22	.60	.62	.09	.78	.13	.13	.13	NR	NR	NR	NR	NR	NR	NR
53D	1.99	0.49	1.10	0.21	0.21	0.21	.70	.20	.50	.09	.70	.20	.20	.20	NR	NR	NR	NR	NR	NR	NR
54D	2.02	0.63	1.39	0.21	0.21	0.21	.75	.19	.56	.09	.65	.24	.24	.24	NR	NR	NR	NR	NR	NR	NR
56AE	2.30	0.63	1.67	0.21	0.21	0.21	.82	.24	.58	.09	.82	.24	.24	.24	NR	NR	NR	NR	NR	NR	NR
57D	2.02	0.50	1.52	0.19	0.19	0.19	.83	.16	.67	.09	.83	.18	.18	.18	NR	NR	NR	NR	NR	NR	NR
61D	1.06	0.28	0.78	0.19	0.19	0.19	.38	.18	.20	.09	.38	.18	.18	.18	NR	NR	NR	NR	NR	NR	NR
66D	1.94	0.44	1.50	0.19	0.19	0.19	.92	.28	.64	.09	.92	.28	.28	.28	NR	NR	NR	NR	NR	NR	NR
67D	1.06	0.27	0.79	0.19	0.19	0.19	.30	.12	.18	.09	.30	.12	.12	.12	NR	NR	NR	NR	NR	NR	NR
69D	1.06	0.52	1.56	0.19	0.19	0.19	1.26	.20	1.08	.09	.68	.49	.49	.49	NR	NR	NR	NR	NR	NR	NR
70D	2.33	0.51	1.82	0.19	0.19	0.19	.68	.19	.86	.09	.68	.19	.19	.19	NR	NR	NR	NR	NR	NR	NR
72AE	NR	NR	NR	0.19	0.19	0.19	1.21	.35	.86	.09	1.10	.27	.27	.27	NR	NR	NR	NR	NR	NR	NR
73D	1.79	0.45	1.34	0.19	0.19	0.19	NR	NR	NR	.09	NR	NR	NR	NR	NR	NR	NR	NR	NR	NR	NR
77D	2.00	0.48	1.52	0.19	0.19	0.19	NR	NR	NR	.09	NR	NR	NR	NR	NR	NR	NR	NR	NR	NR	NR
79D	2.37	0.61	1.76	0.19	0.19	0.19	.72	.22	.50	.09	.72	.22	.22	.22	NR	NR	NR	NR	NR	NR	NR
38A	2.44	0.59	1.85	0.19	0.19	0.19	1.18	.18	.64	.09	.82	.22	.22	.22	NR	NR	NR	NR	NR	NR	NR
39A	1.33	0.36	0.97	0.19	0.19	0.19	1.28	.20	.98	.09	.82	.22	.22	.22	NR	NR	NR	NR	NR	NR	NR
40A	1.71	0.45	1.26	0.20	0.20	0.20	.69	.15	1.13	.09	.52	.28	.28	.28	NR	NR	NR	NR	NR	NR	NR
41A	2.27	0.60	1.87	0.19	0.19	0.19	.37	.12	.25	.09	.37	.12	.12	.12	NR	NR	NR	NR	NR	NR	NR
42A	1.28	0.32	0.96	0.19	0.19	0.19	.88	.17	.71	.09	.88	.17	.17	.17	NR	NR	NR	NR	NR	NR	NR
43A	2.27	0.54	1.73	0.19	0.19	0.19	.50	.17	.33	.09	.50	.17	.17	.17	NR	NR	NR	NR	NR	NR	NR
44A	0.95	0.29	0.66	0.19	0.19	0.19	1.77	.19	1.58	.09	.70	.52	.52	.52	NR	NR	NR	NR	NR	NR	NR
45A	2.31	0.53	1.78	0.19	0.19	0.19	.32	.12	.20	.09	.32	.12	.12	.12	NR	NR	NR	NR	NR	NR	NR
46A	0.94	0.28	0.66	0.19	0.19	0.19	1.00	.22	.78	.09	.84	.37	.37	.37	NR	NR	NR	NR	NR	NR	NR
47A	2.37	0.53	1.84	0.19	0.19	0.19	.39	.16	.23	.09	.39	.16	.16	.16	NR	NR	NR	NR	NR	NR	NR
48A	NR	NR	NR	0.19	0.19	0.19	1.04	.50	.54	.09	1.04	.50	.50	.50	NR	NR	NR	NR	NR	NR	NR
49A	2.48	0.73	1.75	0.19	0.19	0.19	NR	NR	NR	.09	NR	NR	NR	NR	NR	NR	NR	NR	NR	NR	NR
50A	2.71	0.76	1.95	0.19	0.19	0.19	1.45	.28	1.17	.09	1.45	.28	.28	.28	NR	NR	NR	NR	NR	NR	NR
51A	1.98	0.49	1.49	0.19	0.19	0.19	1.75	.42	1.33	.08	1.75	.42	.42	.42	NR	NR	NR	NR	NR	NR	NR
52A	2.10	0.56	1.54	0.19	0.19	0.19	1.02	.28	.74	.09	1.02	.28	.28	.28	NR	NR	NR	NR	NR	NR	NR
53A	2.41	0.58	1.83	0.19	0.19	0.19	1.72	.20	1.52	.09	1.72	.20	.20	.20	NR	NR	NR	NR	NR	NR	NR
54A	2.56	0.71	1.85	0.19	0.19	0.19	1.22	.60	.62	.09	1.22	.60	.60	.60	NR	NR	NR	NR	NR	NR	NR
55A	0.94-2.71	Average Dmax	1.93	0.19	0.19	0.19	1.10	.52	.38	.09	1.10	.52	.52	.52	NR	NR	NR	NR	NR	NR	NR
56A	0.19-0.84	Average Dmin	0.52	0.19	0.19	0.19	NR	NR	NR	.09	NR	NR	NR	NR	NR	NR	NR	NR	NR	NR	NR
57A	0.19-0.21	Average Gross Fog	0.19	0.19	0.19	0.19	NR	NR	NR	.09	NR	NR	NR	NR	NR	NR	NR	NR	NR	NR	NR
58A	0.30-1.77	Limiting Dmax Range	0.30-1.77	0.30-1.77	0.30-1.77	0.30-1.77	NR	NR	NR	.09	NR	NR	NR	NR	NR	NR	NR	NR	NR	NR	NR
59A	0.08-0.69	Average Limiting Dmax	0.08-0.69	0.08-0.69	0.08-0.69	0.08-0.69	NR	NR	NR	.09	NR	NR	NR	NR	NR	NR	NR	NR	NR	NR	NR
60A	0.10-0.52	Limiting Dmin Range	0.10-0.52	0.10-0.52	0.10-0.52	0.10-0.52	NR	NR	NR	.09	NR	NR	NR	NR	NR	NR	NR	NR	NR	NR	NR
61A	0.08-0.27	Average Limiting Dmin	0.08-0.27	0.08-0.27	0.08-0.27	0.08-0.27	NR	NR	NR	.09	NR	NR	NR	NR	NR	NR	NR	NR	NR	NR	NR
62A	0.08-0.09	Gross Fog Range	0.08-0.09	0.08-0.09	0.08-0.09	0.08-0.09	NR	NR	NR	.09	NR	NR	NR	NR	NR	NR	NR	NR	NR	NR	NR
63A	0.08-0.09	Average Gross Fog	0.08-0.09	0.08-0.09	0.08-0.09	0.08-0.09	NR	NR	NR	.09	NR	NR	NR	NR	NR	NR	NR	NR	NR	NR	NR

~~TOP SECRET RUFF~~
~~NO FOREIGN DISSEM~~

Handle Via
TALENT KEYHOLE
Control System Only

Mission 1015-2

Pass	Frame	Dmax	Dmin	Delta	Gross Fog	Pass	Frame	Dmax	Dmin	Delta	Gross Fog
81DE	1	3.12	1.27	1.85	0.21	151D	206	2.06	0.72	1.34	0.21
83U	2	1.73	0.48	1.25	0.23	152AF	219	2.26	1.16	1.10	0.20
84D	13	2.40	0.90	1.50	0.29	152D	220	NR	NR	NR	0.21
85D	14	1.88	0.85	1.03	0.23	152D	221	NR	NR	NR	0.21
86D	33	2.42	1.16	1.26	0.27	161D	222	1.93	0.90	1.03	0.21
87D	34	1.60	0.49	1.11	0.20	162D	235	2.50	1.14	1.36	0.21
88AS	55	2.70	1.36	1.34	0.20	164D	236	1.58	0.31	1.57	0.22
88D	56	1.42	0.34	1.08	0.23	165D	242	2.00	0.62	1.38	0.22
142D	67	2.59	1.04	1.55	0.20	166D	243	1.48	0.34	1.14	0.23
145D	68	2.38	1.10	1.28	0.21	167AE	253	2.21	0.77	1.44	0.21
146D	87	2.68	1.44	1.24	0.34	167D	254	1.58	0.34	1.24	0.21
147D	88	NR	NR	NR	0.25	168D	288	2.53	1.29	1.24	0.21
148D	89	NR	NR	NR	0.25	168D	289	1.99	0.35	1.64	0.21
149D	90	2.28	0.92	1.36	0.27	167D	307	2.20	1.10	1.10	0.20
150D	95	2.62	1.08	1.54	0.21	167D	308	1.62	0.32	1.30	0.20
150D	96	2.45	1.42	1.03	0.22	167AE	330	2.20	1.08	1.12	0.20
150D	99	2.28	1.20	1.08	0.22	167D	331	NR	NR	NR	0.21
150D	100	1.38	0.38	1.00	0.27	167D	332	NR	NR	NR	0.22
150D	104	1.59	0.55	1.04	0.28	168D	333	2.02	0.49	1.53	0.20
150D	105	1.40	0.33	1.07	0.22	168D	346	2.39	1.00	1.39	0.20
150D	112	2.40	0.95	1.45	0.22	172D	347	2.07	1.16	0.91	0.21
150D	113	1.89	0.55	1.34	0.21	172D	359	2.40	1.32	1.08	0.20
150D	127	2.20	1.09	1.11	0.21	173D	360	2.57	1.29	1.28	0.21
150D	128	1.38	0.30	1.08	0.22	173D	367	1.95	0.82	1.13	0.22
150D	170	2.41	1.08	1.33	0.21	174D	368	2.50	1.22	1.28	0.22
150D	171	1.80	0.49	1.31	0.21	174D	371	2.61	1.39	1.22	0.22
150D	192	2.54	1.00	1.54	0.22	174D	372	2.01	1.00	1.01	0.22
150D	193	1.90	0.62	1.28	0.22	174D	379	2.55	1.32	1.23	0.21
150D	205	2.22	1.14	1.08	0.22						

Dmax Range 1.38-3.12
 Dmin Range 0.30-1.44
 Gross Fog Range 0.20-0.34

Average Dmax 2.09
 Average Dmin 0.86
 Average Gross Fog 0.22

The material acquired from Index Camera No D58
 (Mission 1015-2) is not available for
 density readings.

Handle Via
~~TALENT-KEYHOLE~~
Control System Only

APPENDIX C. MICRODENSITOMETRY

1. Edge Spread Function:

The technique of obtaining the spread function from microdensitometer edge traces is used as an objective measure of the image quality in mission photography. The spread function curve represents a summation of the separate elements of the photographic system. By taking the Fourier Transform of the spread function the modulation transfer function of the system may be obtained.

To satisfy the desire to express image quality in terms of a value, a single number is determined from the spread function curve by measuring its width at 50 percent amplitude. This width is expressed as a micron distance in image space and may be converted to a distance on the ground. On domestic passes, where 3 bar resolution targets have been available, the ground distance determined from edge trace analysis and from the targets has been found to be comparable.

The microdensitometric analysis of edges in the image requires that the object edge fulfill the conditions of a unit step function, i.e., exist for an appreciable distance at a fixed brightness level and change abruptly to a new level which exists for an appreciable distance. This requirement is usually achieved by rooftops of buildings in large-scale photography, and aircraft runways or taxiways in small-scale photography.

The mission is examined to determine the MIP (Mission Information Potential) frame, which is a subjective selection of the best photography. Straight edges in this imagery meeting the criteria of a step function for a length of at least 120 microns are selected for scanning with the microdensitometer.

Handle Via
~~TALENT-KEYHOLE~~
Control System Only

~~TOP SECRET RUFF~~

~~NO FOREIGN DISSEM~~

Handle Via
~~TALENT KEYHOLE~~
Control System Only

The microdensitometer used is a Joyce-Loebel Double Beam Model III CS. It is used with an effective slit of 1 micron by 75 microns. The recording table and specimen table are directly linked with a 1,000:1 ratio arm. The speed of the scan is proportional to the rate of pen deflection (as the pen deflection rate increases the speed is decreased giving the pen time to reach its maximum response). The trace thus produced represents a plot of deflection versus distance. The deflection of the pen is essentially linear with density.

Several computer programs that have as output both the spread function and MIF are currently being investigated. The best features of each will be incorporated into a program for the UNIVAC 490. In the interim the data reduction is done manually.

The microdensitometer plots, which exhibit the steepest density gradients and fall on the straight-line portion of the H & D curve for the material, are traced and smoothed. They are then digitized in a comparator into values of distance (X) and deflection (Y). Since the instrument response is linear with density, it is also linear with exposure on the straight-line portion of the applicable D Log E curve. The values of Y are converted to Log E and the antilog taken to obtain values of relative exposure. The difference between adjacent values of E is divided by the corresponding difference of the measured values of X to produce the slope values (dE/dX) of the original object reflectance distribution. Finally, 50 percent of the maximum slope is computed, and the distance between the 50 percent slope values is determined by interpolation. The Line Spread Function (LSF) may also be plotted (slope versus distance) and the 50 percent amplitude width measured for verification of the calculated value.

The following table shows the 50 percent amplitude width of the LSF determined from the enclosed microdensitometric edge traces made on the original negative. The lines per millimeter is determined by taking the reciprocal of the 50 percent amplitude width LSF, and converting to millimeters.

- 40 -

Handle Via
~~TALENT KEYHOLE~~
Control System Only

~~TOP SECRET RUFF~~

~~NO FOREIGN DISSEM~~

Handle Via
~~TALANT KEYHOLE~~
Control System Only

SUMMARY TABLE OF EDGE TRACES

Trace Number	Line Spread Function Width at 50% Amplitude	Reciprocal of LSF Width at 50% Amplitude
1015-1		
1	16.72 microns	59.80 L/mm
2	13.71 microns	72.90 L/mm
3	13.90 microns	71.60 L/mm
1015-2		
4	15.44 microns	64.80 L/mm
5	18.01 microns	55.50 L/mm

Handle Via
~~TALANT KEYHOLE~~
Control System Only

~~TOP SECRET RUFF~~
~~NO FOREIGN DISSEM~~

Handle Via
~~TALENT KEYHOLE~~
Control System Only



FIGURE 13. TARGET, MICRODENSITOMETRIC TRACE NO 1.

NPIC K-1070 10/80

- 42a -

~~TOP SECRET RUFF~~
~~NO FOREIGN DISSEM~~

Handle Via
~~TALENT KEYHOLE~~
Control System Only

Handle Via
~~TALENT-KEYMOLE~~
Control System Only

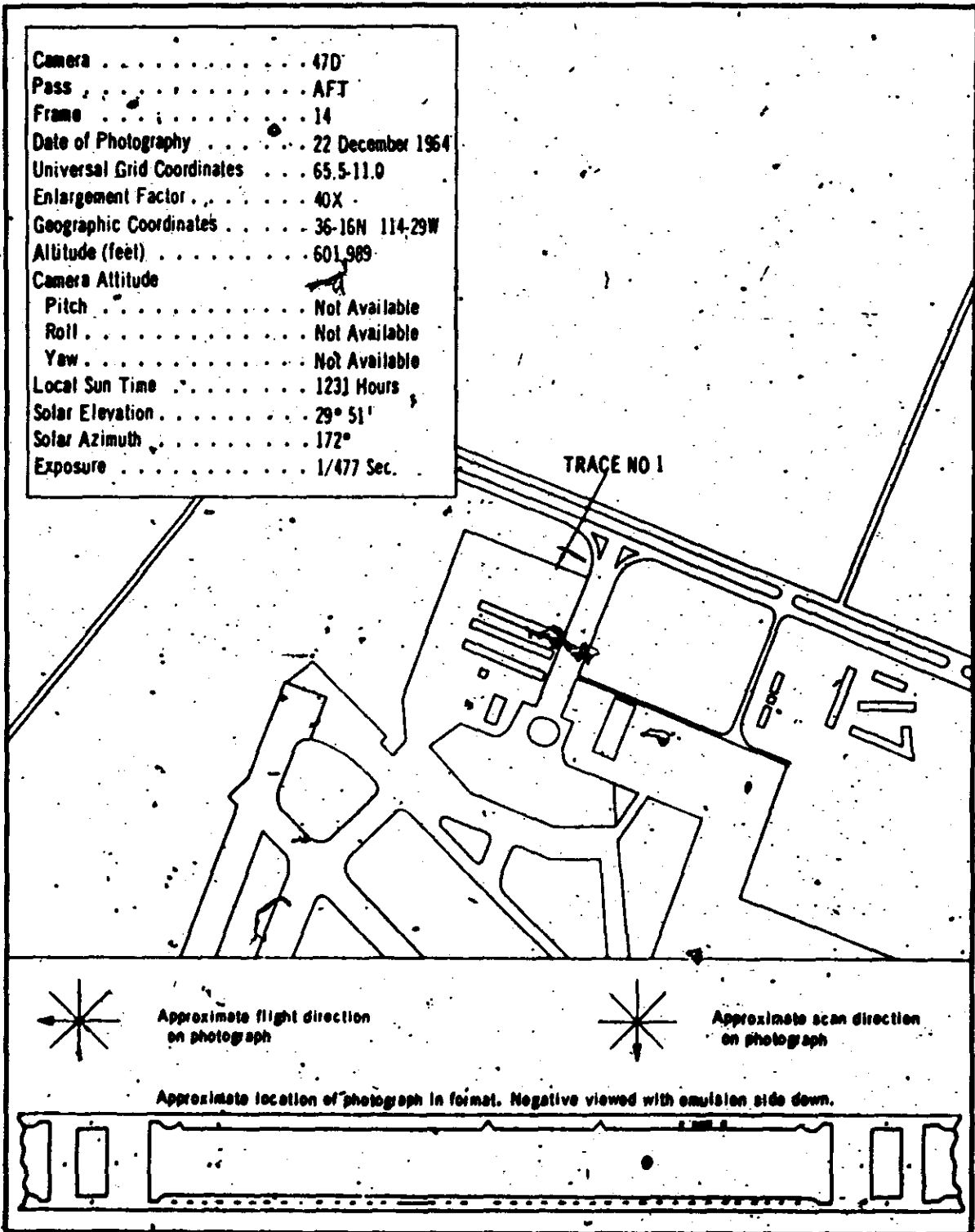

Handle Via
~~TALENT-KEYMOLE~~
Control System Only

~~TOP SECRET - RUFF~~
NO FOREIGN DISSEM.

Handle Via
~~TALENT-KEYHOLE~~
Control System Only

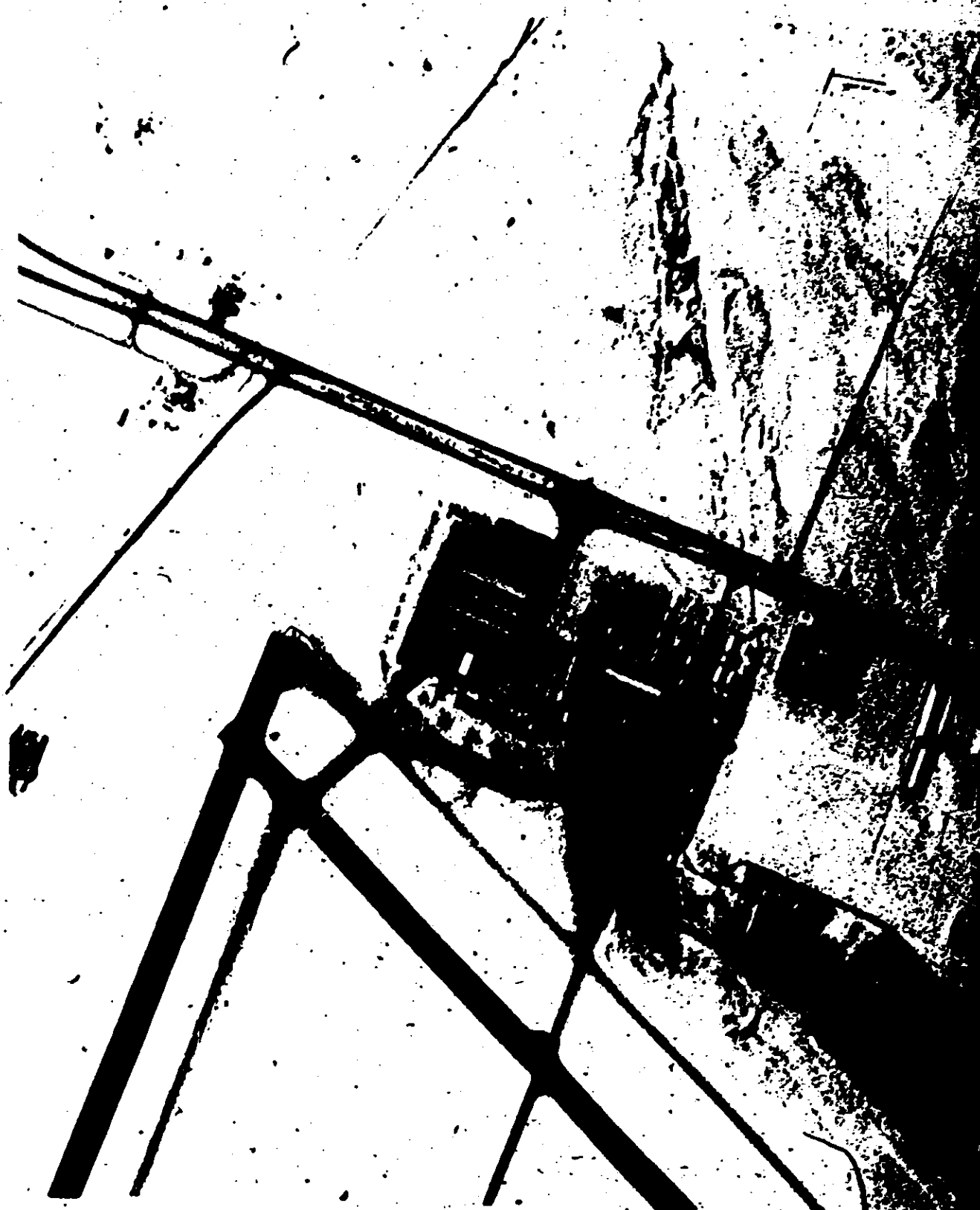

~~TOP SECRET - RUFF~~
NO FOREIGN DISSEM.

Handle Via
~~TALENT-KEYHOLE~~
Control System Only

~~TOP SECRET RUFF~~

~~NO FOREIGN DISSEM~~

Handle Via
~~TALENT KEYHOLE~~
Control System Only

MICRODENSITOMETRIC TRACE

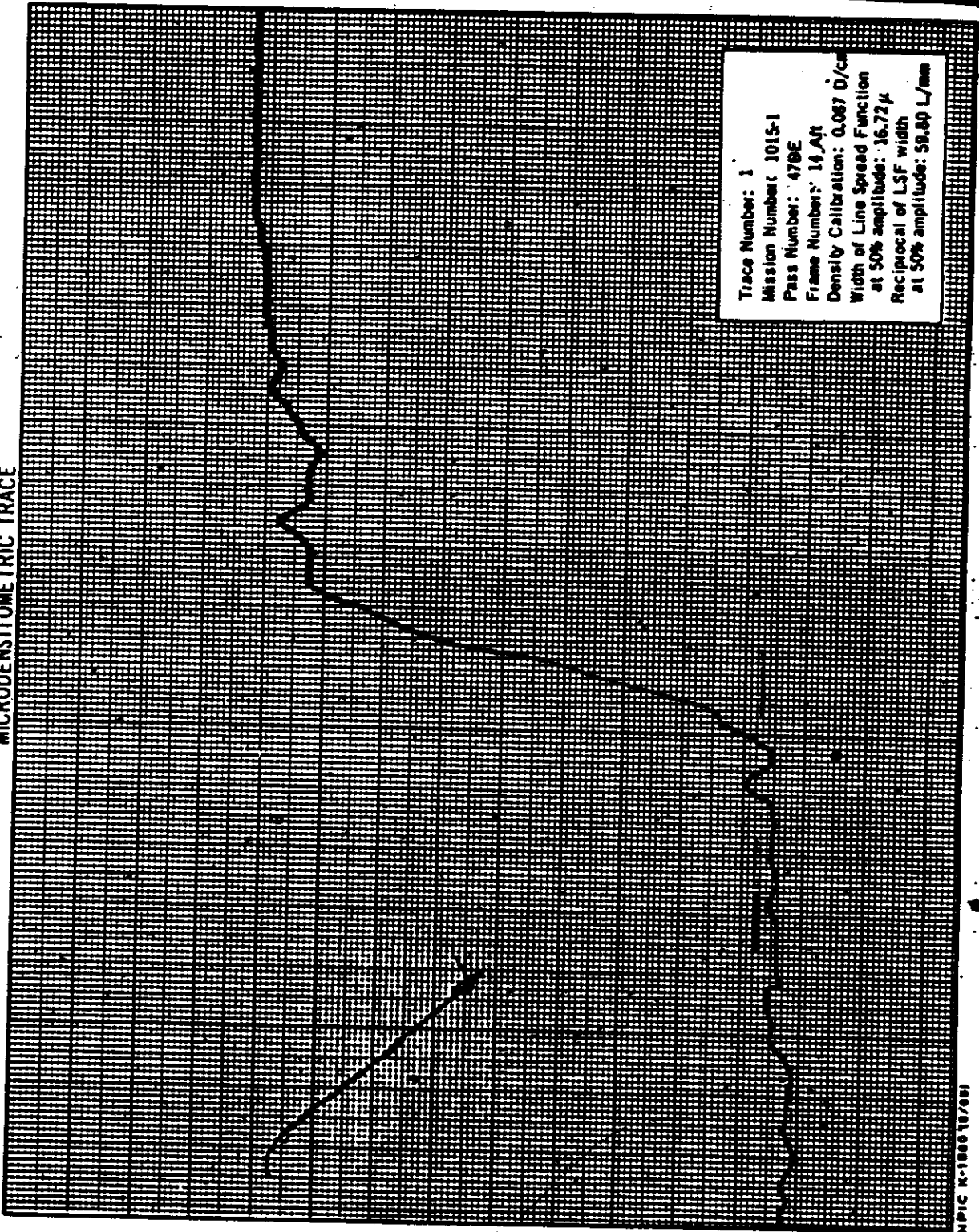

Trace Number: 1
Mission Number: 1015-1
Pass Number: 478E
Frame Number: 14, Alt
Density Calibration: 0.087 D/cm
Width of Line Spread Function
at 50% amplitude: 16.72 μ
Reciprocal of LSF width
at 50% amplitude: 59.80 L/mm

MPIC K-188018/88

~~TOP SECRET RUFF~~

~~NO FOREIGN DISSEM~~

Handle Via
~~TALENT KEYHOLE~~
Control System Only

~~TOP SECRET RUFF~~

~~NO FOREIGN DISSEM~~

Handle Via
TALENT KEYHOLE
Control System Only



• FIGURE 14. TARGET, MICRODENSITOMETRIC TRACES NOS 2 AND 3.

NPIC K-1881 (8/68)

- 44a -

Handle Via
TALENT KEYHOLE
Control System Only

~~TOP SECRET RUFF~~

~~NO FOREIGN DISSEM~~

Handle Via
~~TALENT-KEYHOLE~~
Control System Only

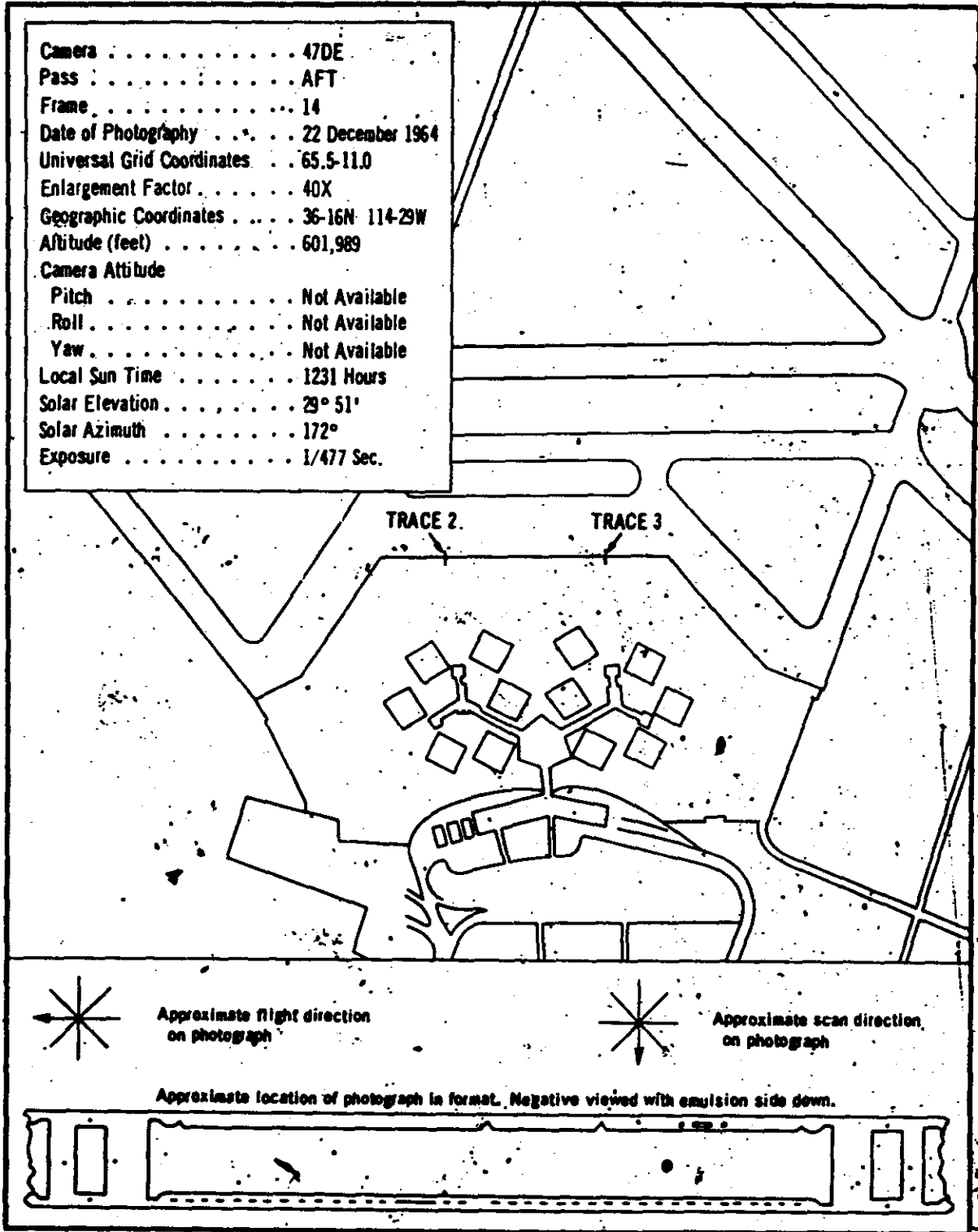

Handle Via
~~TALENT-KEYHOLE~~
Control System Only

~~TOP SECRET - RUFF~~
~~NO FOREIGN DISSEM~~

Handle Via
~~TALENT KEYHOLE~~
Control System Only

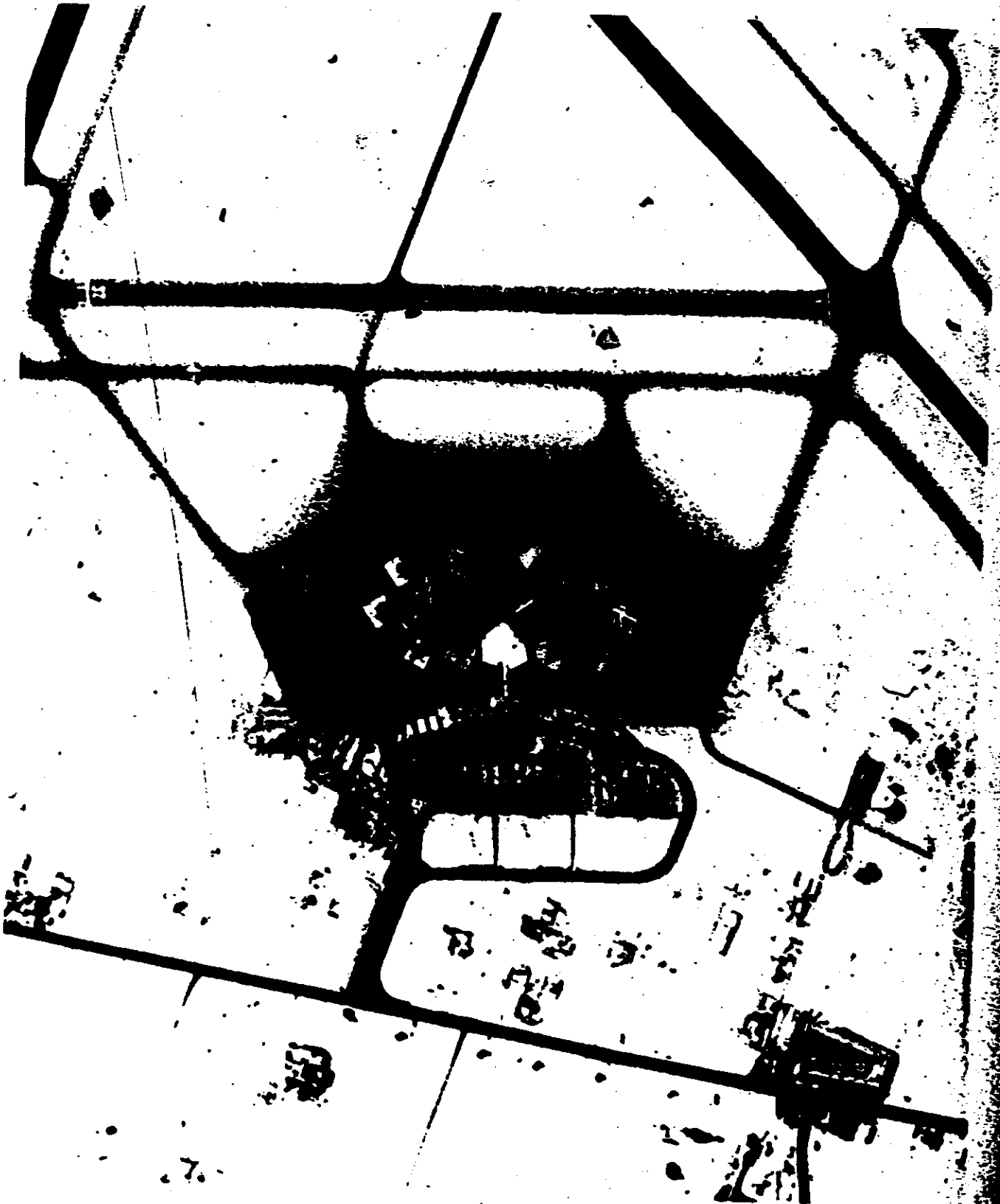

~~TOP SECRET - RUFF~~
~~NO FOREIGN DISSEM~~

Handle Via
~~TALENT KEYHOLE~~
Control System Only

Handle Via
TALENT-KEYHOLE
Control System Only

MICRODENSITOMETRIC TRACE

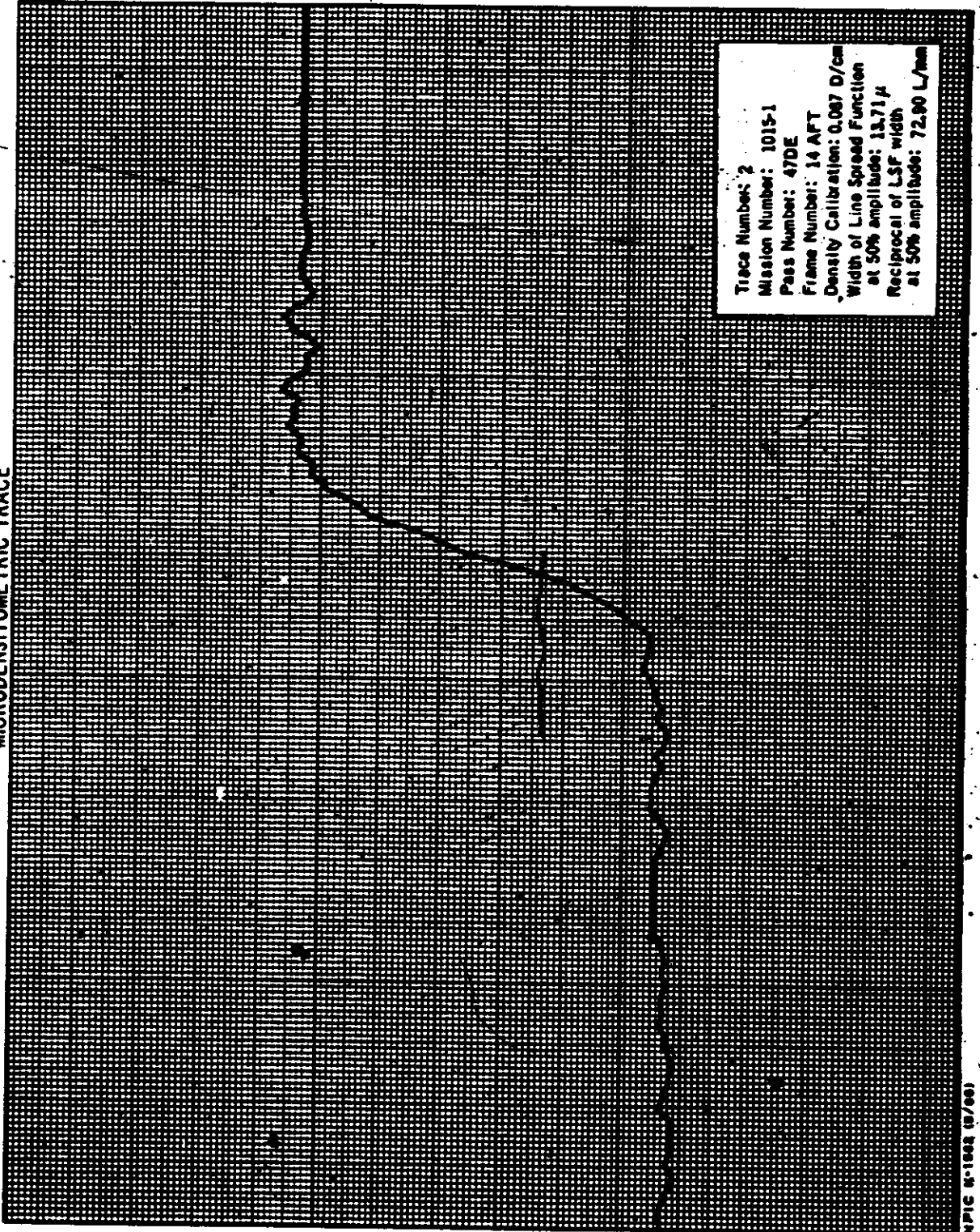

Trace Number: 2
 Mission Number: 1015-1
 Pass Number: 47DE
 Frame Number: 14 AFT
 Density Calibration: 0.007 D/cm
 Width of Line Spread Function
 at 50% amplitude: 13.71 μ
 Reciprocal of LSF width
 at 50% amplitude: 72.90 L/mm

MPIC 8-1002 (8/60)

Handle Via
TALENT-KEYHOLE
Control System Only

Handle Via
CONTROL SYSTEM ONLY
Control System Only

MICRODENSITOMETRIC TRACE

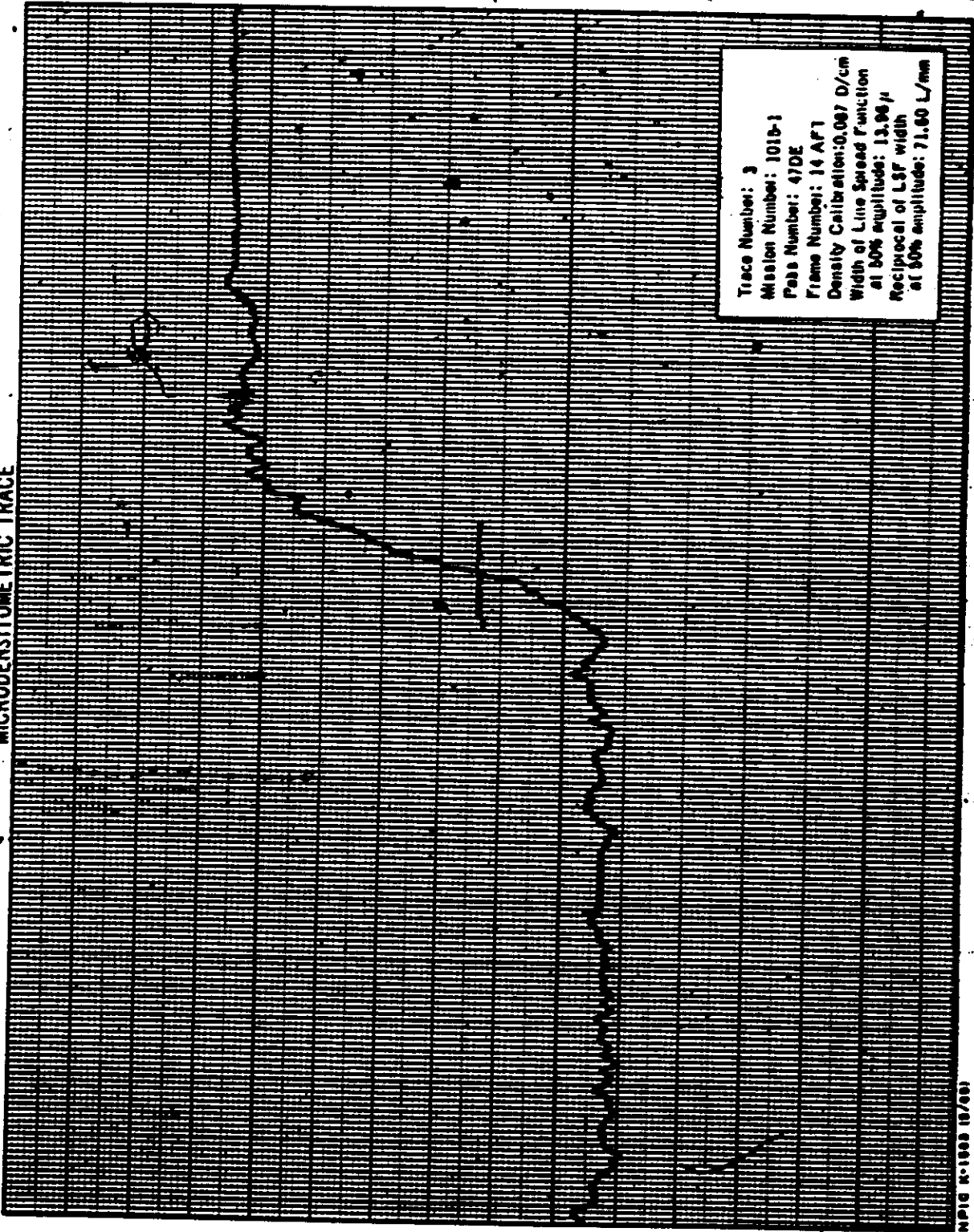

~~TOP SECRET RUFF~~

~~NO FOREIGN DISSEM~~

Handle Via
TALENT KEYHOLE
Control System Only



FIGURE 15. TARGET, MICRODENSITOMETRIC TRACES NOS 4 AND 5.

NPIC K-1004 (B/00)

-2-

- 16a -

Handle Via
TALENT KEYHOLE
Control System Only

~~TOP SECRET RUFF~~

~~NO FOREIGN DISSEM~~

Handle Via
~~TALENT KEYMOLE~~
Control System Only



Camera	AFT
Pass	88D
Frame	24
Date of Photography	25 December 1964
Universal Grid Coordinates	40.5 - 12.0
Enlargement Factor	40x
Geographic Coordinates	Not Available
Altitude (feet)	Not Available
Camera Altitude	
Pitch	Not Available
Roll	Not Available
Yaw	Not Available
Local Sun Time	Not Available
Solar Elevation	Not Available
Solar Azimuth	Not Available
Exposure	Not Available

TRACE 4

TRACE 5

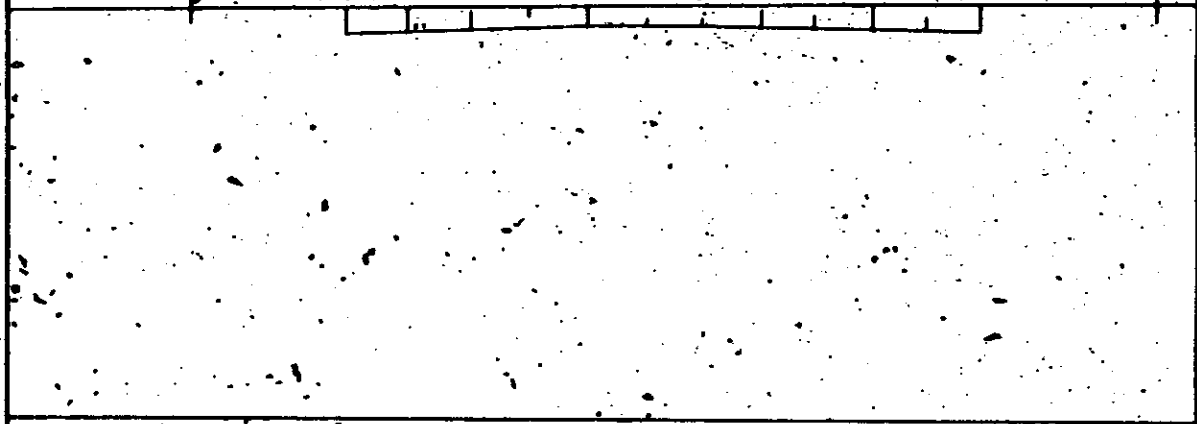

Approximate flight direction
on photograph



Approximate scan direction
on photograph

Approximate location of photograph in format. Negative viewed with emulsion side down.



Handle Via
~~TALENT KEYMOLE~~
Control System Only

TOP SECRET - RUFF
NO FOREIGN DISSEM

Handle Via
TALENT KEYHOLE
Control System Only

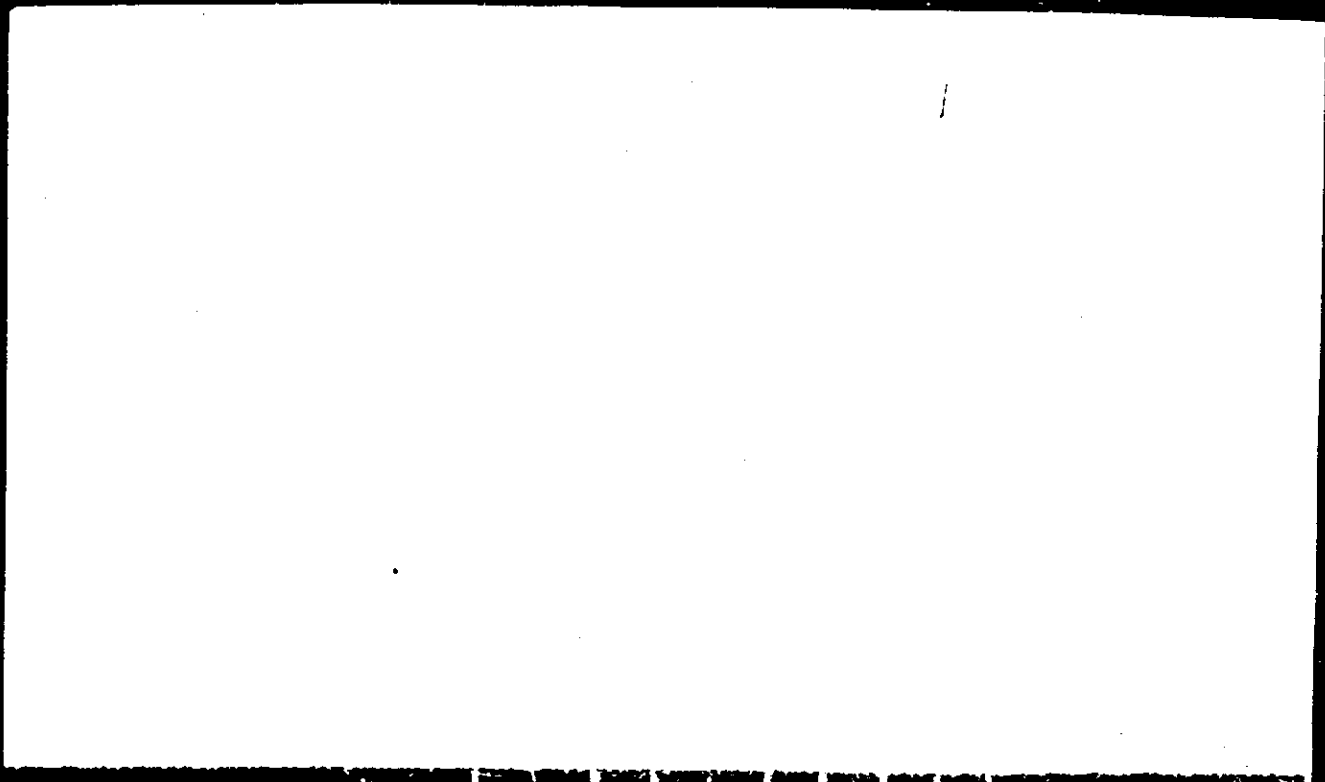

TOP SECRET - RUFF
NO FOREIGN DISSEM

Handle Via
TALENT KEYHOLE
Control System Only

Handle Via
TALENT-KEYHOLE
Control System Only

MICRODENSITOMETRIC TRACE

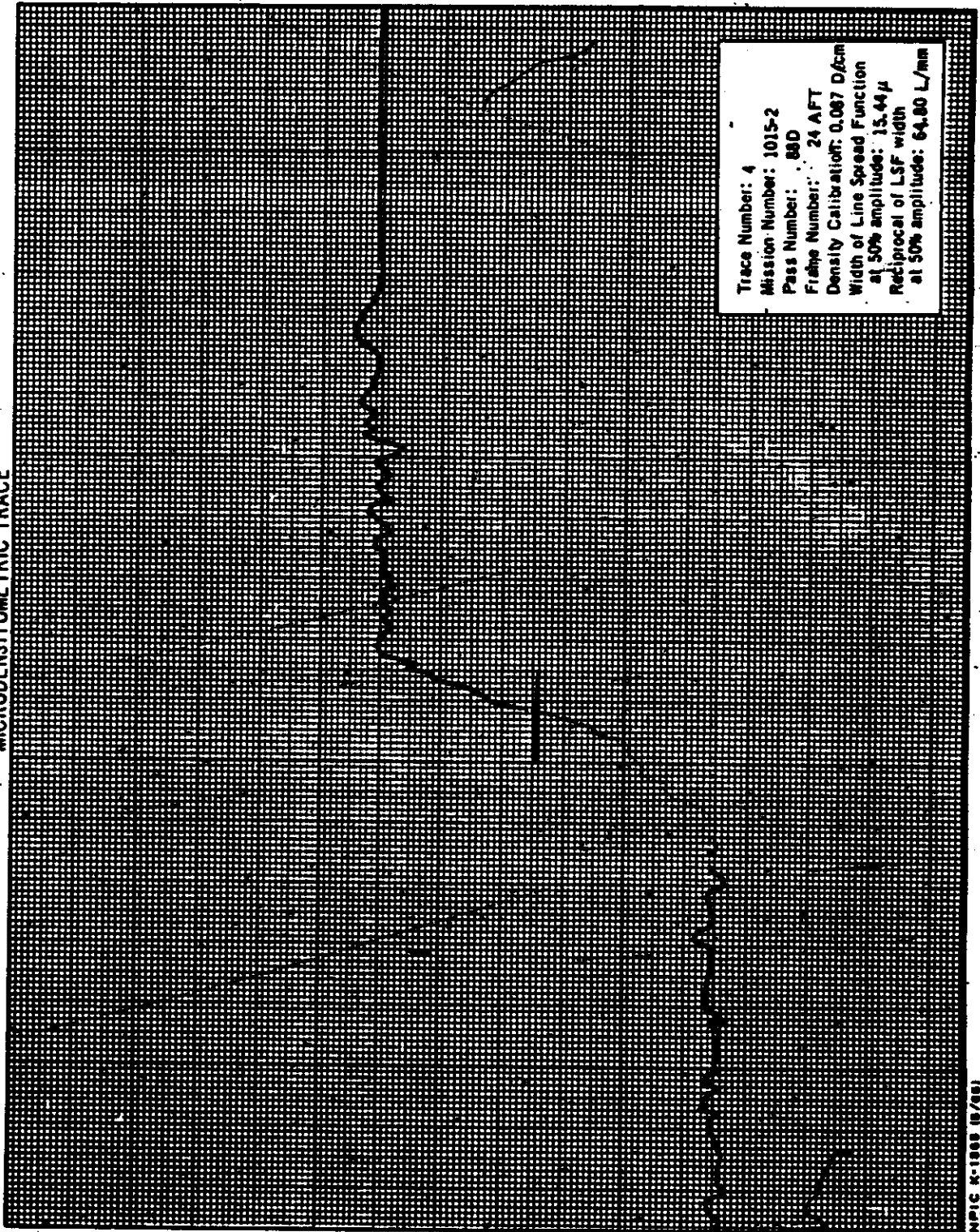

Trace Number: 4
 Mission Number: 1015-2
 Pass Number: 88D
 Frame Number: 24 AFT
 Density Calibration: 0.087 D/cm
 Width of Line Spread Function
 at 50% amplitude: 15.44 μ
 Reciprocal of LSF width
 at 50% amplitude: 64.80 L/mm

NPIC K-1000 (8/60)

Handle Via
TALENT-KEYHOLE
Control System Only

Handle Via
TALENT KEYHOLE
Control System Only

MICRODENSITOMETRIC TRACE

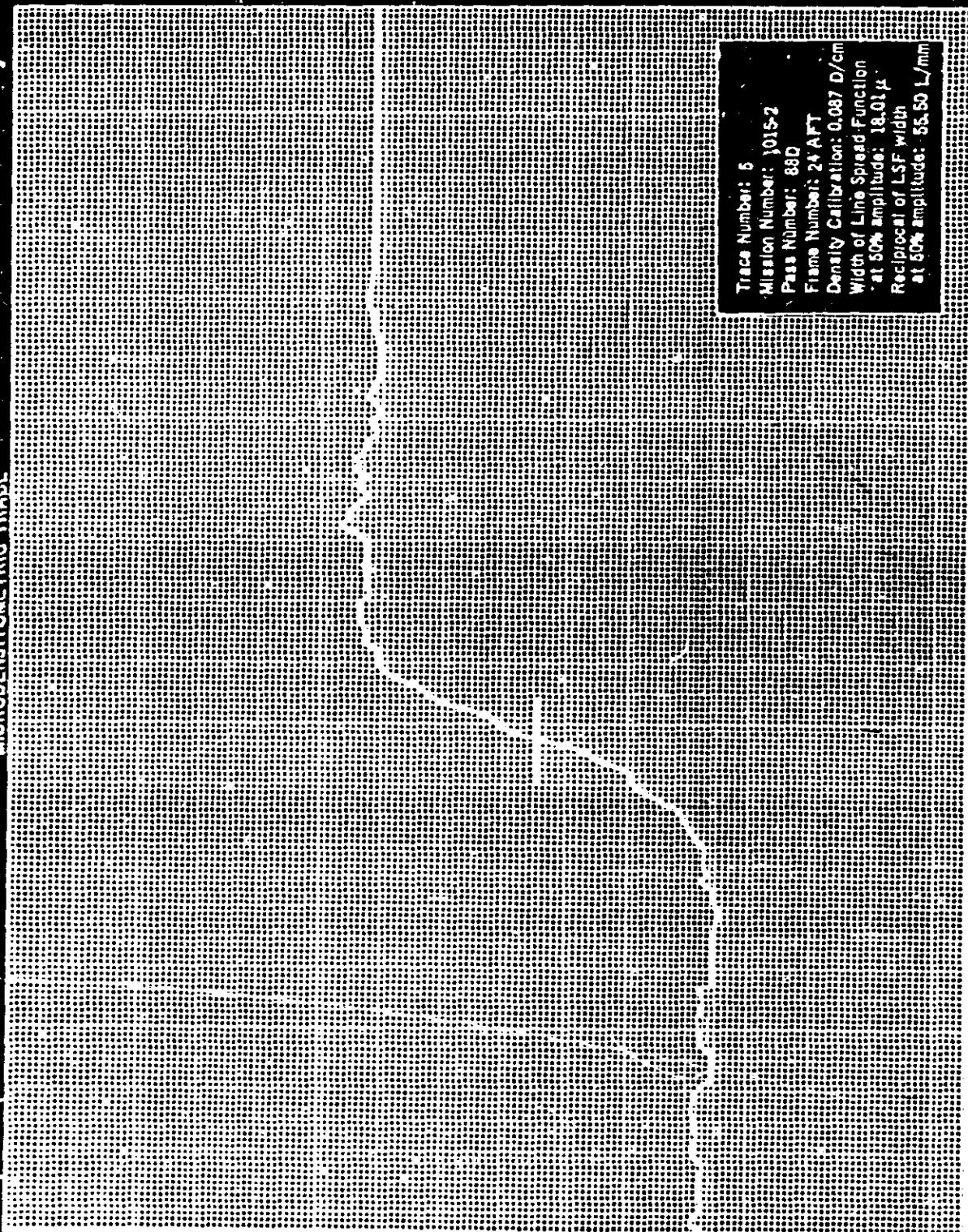

Trace Number: 5
 Mission Number: 1015-2
 Pass Number: 88D
 Frame Number: 24 AFT
 Density Calibration: 0.087 D/cm
 Width of Line Spread Function
 at 50% amplitude: 18.0 μ
 Reciprocal of LSF width
 at 50% amplitude: 55.50 L/mm

APG 3 1519 10/97

Handle Via
TALENT KEYHOLE
Control System Only

Handle Via
~~TALENT KEYHOLE~~
Control System Only

APPENDIX B. TEMPERATURE DATA

1. Summary of Temperature Effects, Mission 1015:

Although the temperature readings are considerably below normal, no image degradation is detectable. Ordinarily, there is little latitude for the acquisition of good-quality photography in abnormal temperature environments. Consequently, the apparent stability of the photographic quality in Mission 1015 is a matter of interest. With this in mind, it is worth noting that the panoramic camera cones were fitted with invar components. Since invar is a metal with stable expansion/contraction characteristics, it is reasonable to assume that its use contributed to the consistency of the photographic quality achieved in this mission.

2. Sensor Locations and In-Flight Temperature Samplings:

The following sensor location diagrams and in-flight temperature samplings were provided by the camera manufacturer for inclusion in this report.

Handle Via
~~TALENT KEYHOLE~~
Control System Only

Handle Via
TALENT KEYHOLE
Control System Only

7" PROFILE TO SHOW APPROXIMATE TEMP SENSOR LOCATIONS

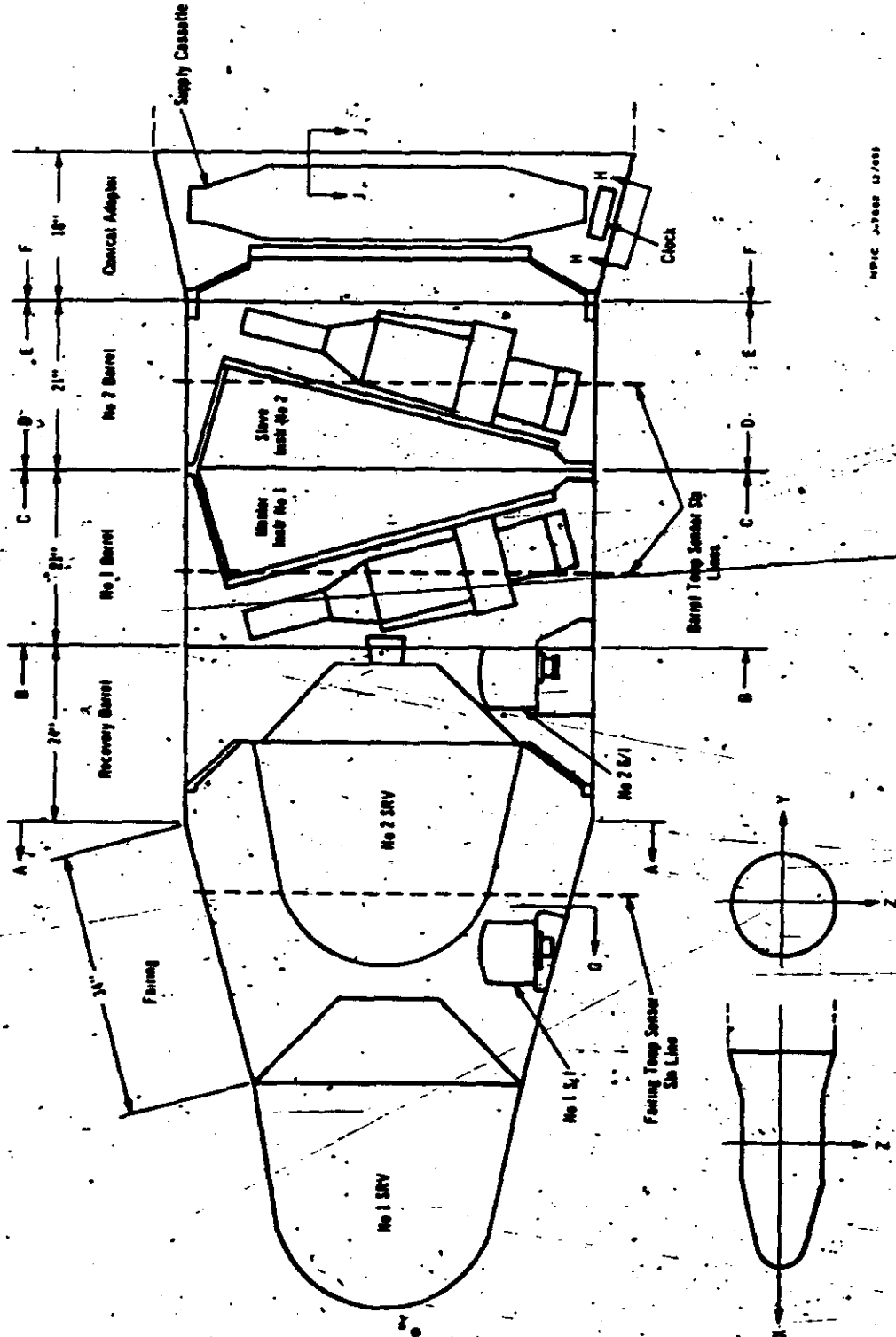

Handle Via
TALENT KEYHOLE
Control System Only

Handle Via
TALENT KEYHOLE
Control System Only

FAIRING TEMP SENSORS

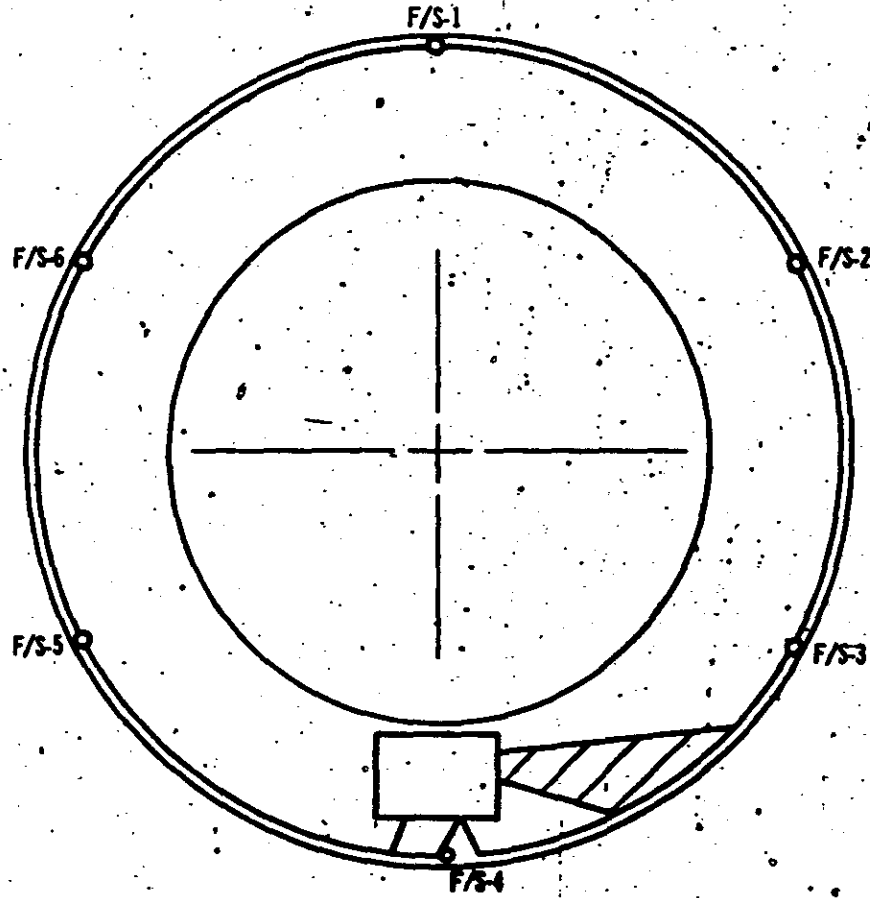

VIEW A-A
LOOKING FORWARD

NPIC J-7688 (2/68)

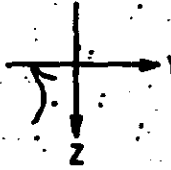

Handle Via
TALENT KEYHOLE
Control System Only

Handle Via
~~TALENT KEYHOLE~~
Control System Only



NO 1 & NO 2 TEMP SENSORS (FRONT FACE)
NO 1 & NO 2 BARREL TEMP SENSORS (SKIN)

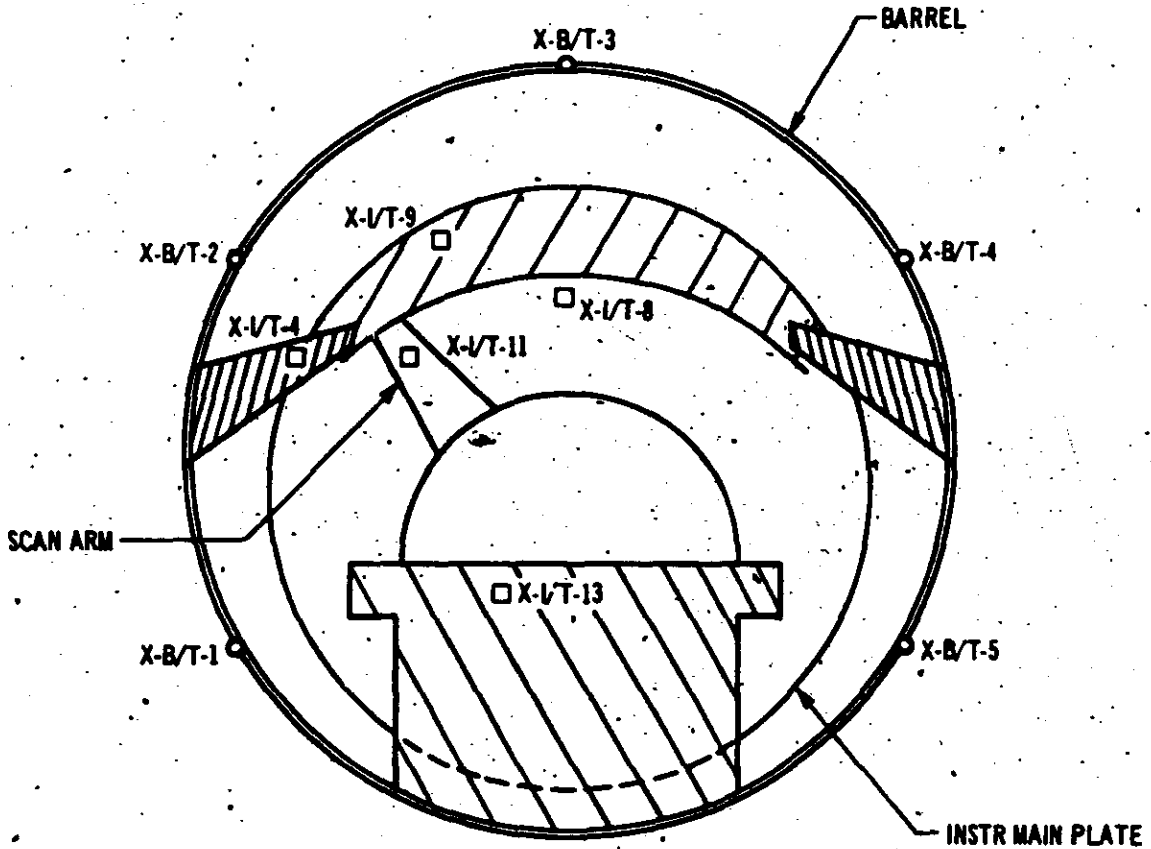

VIEW B-B & F-F
INSTR NO 1 LOOKING AFT
INSTR NO 2 LOOKING FWD

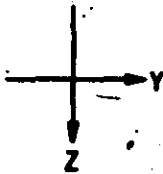

INSTR NO 2

NDIC 3-8287 (2/68)

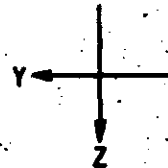

INSTR NO 1

Handle Via
~~TALENT KEYHOLE~~
Control System Only

Handle Via
~~TALENT KEYHOLE~~
Control System Only

NO 1 & NO 2 INSTR TEMP SENSORS (BACKFACE)
NO 1 & NO 2 BARREL TEMP SENSORS (SKIN)

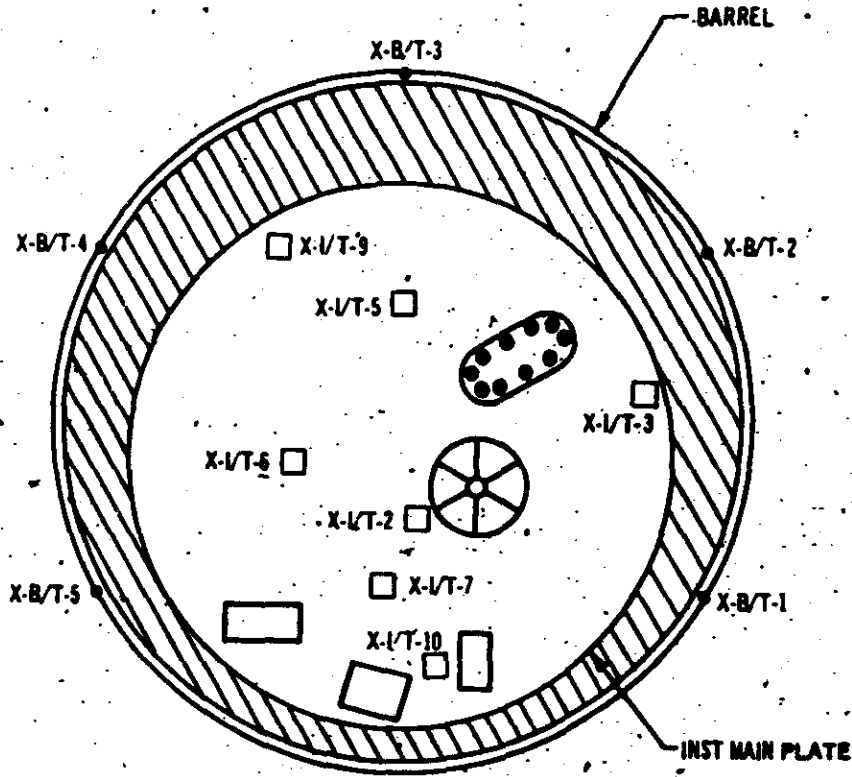

VIEW C-C & D-D
INSTR NO 2 LOOKING AFT
INSTR NO 1 LOOKING FWD

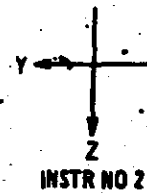
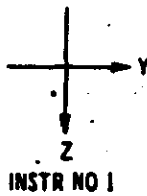

KEY:

X denotes No 1 or No 2 instr or barrel
e.g. X-I/T-6 is No 1 or No 2
instr temp sensor No 6
X-B/T-4 is No 1 or No 2 barrel temp
sensor No 4

NMC J-2200 (2/68)

Handle Via
~~TALENT KEYHOLE~~
Control System Only

Handle Via
~~TALENT KEYHOLE~~
Control System Only

VIEW E-E SUPPLY CASSETTE LOOKING AFT.

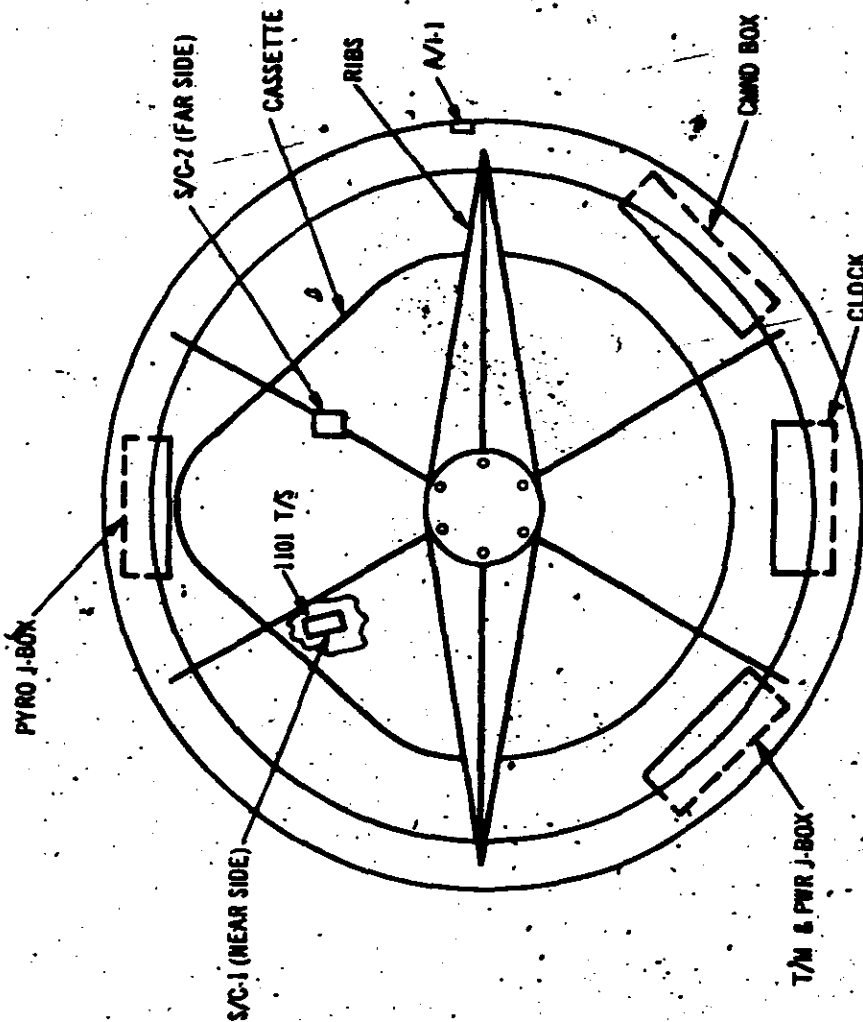

SIDE VIEW SHOWING SPOOLS

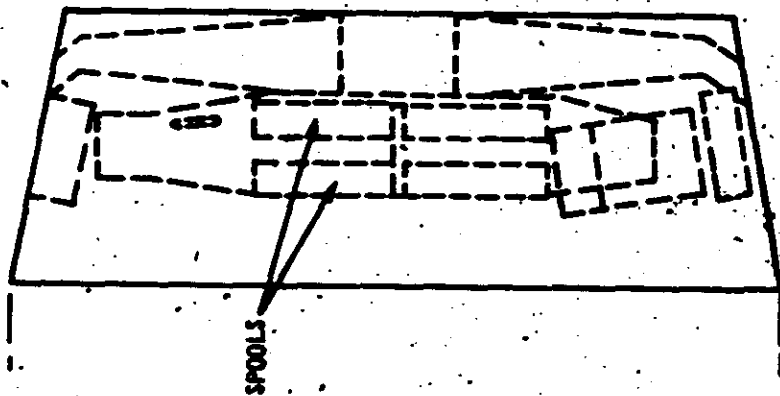

NPIC J-4988 2/681 4

Handle Via
~~TALENT KEYHOLE~~
Control System Only

Handle Via
TALENT KEYHOLE
Control System Only

VIEW G-G
S/I TEMP SENSOR

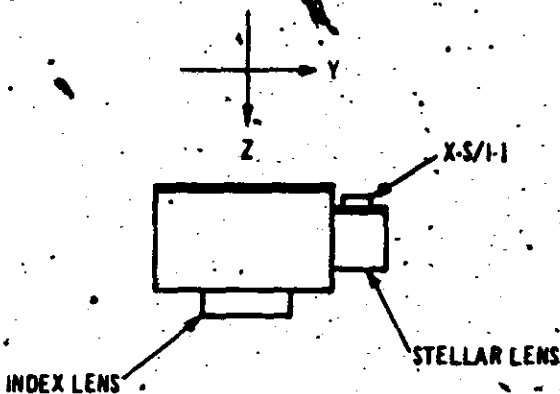

VIEW H-H
CLOCK TEMP SENSOR

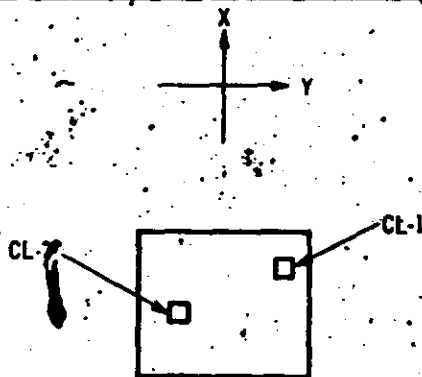

VIEW J-J
INTERFACE TEMP SENSOR
(SENSOR ON-Y AXIS)

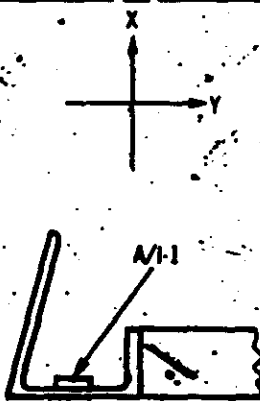

NPIC J-8388 12/001

Handle Via
TALENT KEYHOLE
Control System Only

~~TOP SECRET RUFF~~
~~NO FOREIGN DISSEM~~

NO 1 AND NO 2 SRV TEMP SENSORS

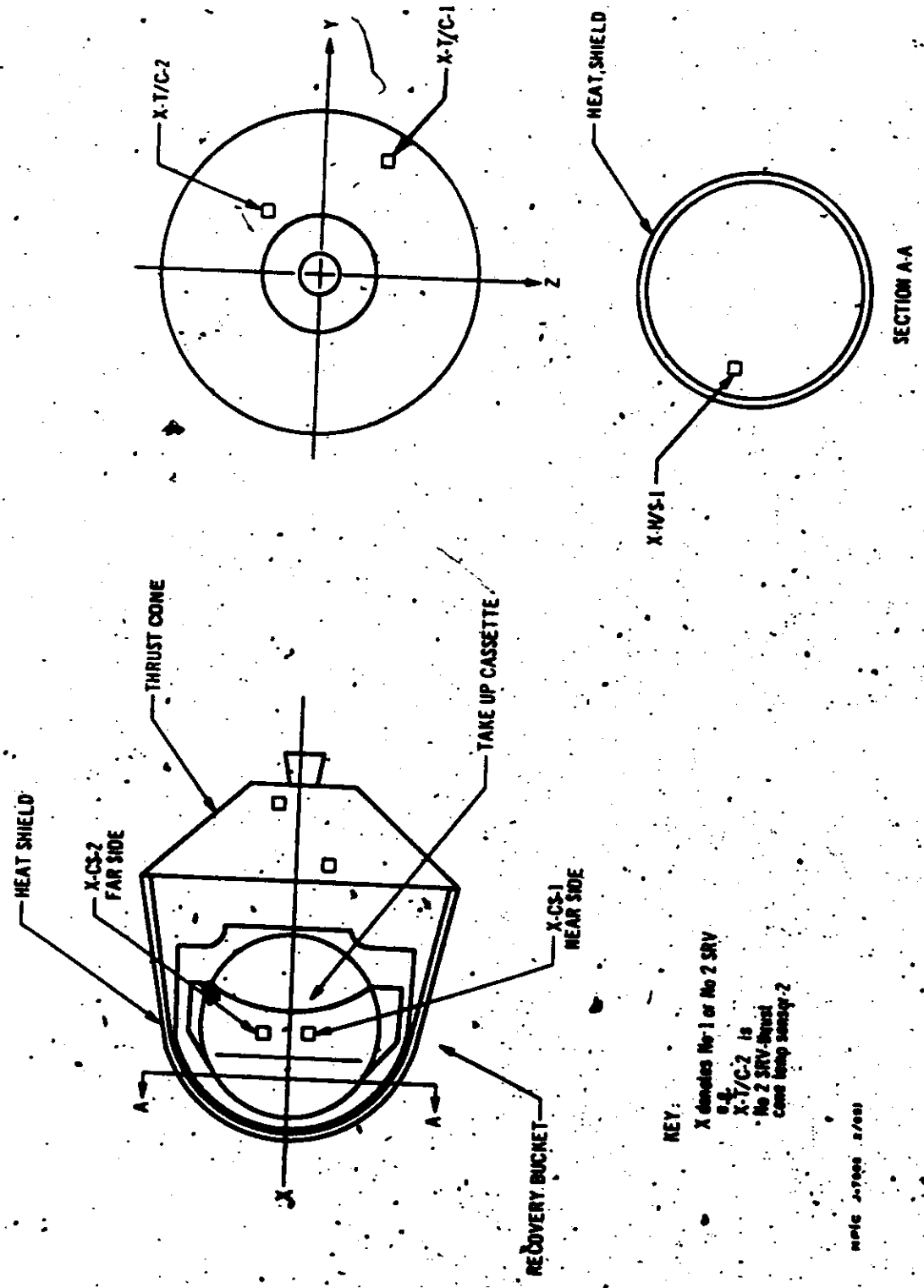

KEY:
 X denotes No 1 or No 2 SRV
 T/C
 X-T/C-2 is
 No 2 SRV-Thrust
 cone temp sensor 2

note J-7000 2/68

~~TOP SECRET RUFF~~
~~NO FOREIGN DISSEM~~

TEMPERATURE SUMMARY

SENSOR	ORBITS ACQUIRED													
	Launch	9	16	25	31	41	47	56	63	72	79	88	142	152
Master														
3	70	55	48	51	48	49	45	47	44	47	42	45	36	40
4	73	64	58	58	57	59	50	55	52	54	52	53	43	48
5	70	67	60	61	59	60	51	57	54	57	53	54	42	47
6	66	74	68	67	66	65	62	61	59	61	58	57	46	48
7	68	68	62	63	61	62	57	58	56	58	55	55	45	48
8	73	67	61	64	60	61	54	57	54	57	53	55	43	47
9	58	65	58	61	57	59	52	55	46	53	49	50	36	40
10	69	66	59	61	59	60	55	56	54	57	52	54	42	47
11*	95	75	71	70	69	72	63	66	64	65	60	61	46	50
12	77	61	55	56	53	56	49	54	49	54	49	52	41	47
13	63	65	61	57	60	59	53	54	53	51	52	52	40	43
AVG. INSTR. TEMP.		65	59	60	55	59	53	55	52	55	51	53	41	45
Slave														
3	66	76	70	65	68	68	63	65	61	64	58	58	42	46
4	71	76	68	64	65	68	63	65	61	62	58	63	44	48
5	68	71	65	59	64	63	59	58	57	62	58	58	45	48
6	66	66	63	56	62	59	58	63	57	59	56	55	46	48
7	65	72	68	61	66	64	62	63	61	64	59	59	49	51
8	69	69	63	57	63	62	58	61	57	61	56	57	44	47
9		63	57	53	57	57	54	55	53	56	51	53	41	46
10	68	70	65	61	64	64	61	62	58	62	57	58	47	50
11*	92	85	81	59	78	79	77	78	77	78	75	73	62	65
12	71	75	71	65	65	68	61	65	59	65	57	59	42	47
13	75	73	71	58	70	68	65	66	66	66	64	62	53	54
AVG. INSTR. TEMP.		72	67	59	65	65	62	63	60	63	59	59	46	50
Supply Spool (SS)														
1	75	58	55	52	53	54	50	50	49	50	48	48	33	37
2	71	61	55	56	54	55	50	53	49	52	48	48	32	37

*Not corrected for self-heating.

Handle Via
~~TALENT KEYHOLE~~
Control System Only

TEMPERATURE SUMMARY

VEHICLE 140

SENSOR	Pairing/Barrel # ("B")	Launch	ORBITS ACQUIRED														
			9	16	25	31	41	47	56	63	72	79	88	142	152		
1		OBH	41	19													
2		OBH	8	-5													
3		OBH	6	2													
4		219	57	44													
5		232	71	58													
6		228	72	59													
7																	
Barrel No. 2																	
1		141	58	64													
2		134	59	71													
3		175	30	30													
4		184	7	1													
5		178	97	15													
Conic Adapter																	
1		156	62	56													
Vlock																	
1		97	65	61	58	63	56	61	54	61	54	54	54	54	54	54	50
2		93	63	58	56	61	52	56	52	56	52	54	54	54	54	54	46
Thrust Cond "A" to "B" SRV																	
1		84	44	39	41	38	41	37	39	33	39	33	39	33	39	33	41
2		109	59	52	54	48	50	40	46	41	45	41	45	41	45	41	44
Stellar/Index "A" to "B"																	
1		88	73	63	66	63	66	60	63	57	57	57	57	57	57	57	48
2		75	62	59	56	59	59	52	56	49	58	49	58	49	54	44	44
Recovery Batt. "B" SRV																	
1		77	76	74	66	70	69	68	66	67	65	64	64	64	64	64	84
Master Cassette "A" SRV																	
2		95	69	63	55	61	60	59	59	60	61	59	60	61	59	60	59

NOTE: Only Thrust Cone Data corrected for Self-heating.

Handle Via
~~TALENT KEYHOLE~~
Control System Only

APPENDIX E. CLOUD COVER ANALYSIS

1. INTRODUCTION

This study represents a statistical analysis of the cloud cover on the photography of Mission 1015. The basis of this study is the cloud cover data for each quarter segment of every individual frame of photography. The data is obtained by analysts specifically trained in estimating cloud cover by designated categories.

Five cloud categories have been formulated for use in this photography (See Table 1). These categories allow for the wide latitude of cloud cover conditions commonly found on a frame of this photography. Note in Table 1 that a mean cloud percentage value has been calculated for each category for use in determining a combined cloud cover percentage for all operational passes of the mission.

The occurrence of each cloud category within an operational pass is expressed as a percentage and appears in Table 2. Each percentage is a ratio of the number of occurrences of a given cloud cover category to the total number of cloud observations in a photography pass. For example: if the number of category 1 occurrences in a given pass is 200 out of a total of 1,000 (250 frames x 4 quarters), all categories combined, then 20 percent of the pass would be classed as category 1.

Also, a cloud cover percentage per pass is included in the last column of Table 2 under "Cloud Cover % Per Pass." This value is determined by the summation of the products of category percentage in each pass and the mean cloud percentage for that category as established in Table 1. For example: if it is determined that the following percentages exist in a given pass:

- 20% Category 1
- 15% Category 2
- 30% Category 3
- 25% Category 4
- 10% Category 5

Handle Via
~~TALENT KEYHOLE~~
Control System Only



Then, by using the mean cloud percentage established in Table 1, the following computations are made:

$$\begin{array}{rcl}
 0.20 \times 5.0 & = & 1.00\% \\
 0.15 \times 17.5 & = & 2.63\% \\
 0.30 \times 38.0 & = & 11.40\% \\
 0.25 \times 75.0 & = & 18.75\% \\
 0.10 \times 100.0 & = & 10.00\% \\
 & & \hline
 & & 43.78\%
 \end{array}$$

Hence, 43.8 percent of this pass is cloud covered.

TABLE 1

CLOUD COVER CATEGORIES

CATEGORY NUMBER	PERCENT OF CLOUD COVER	DESCRIPTION	MEAN CLOUD PERCENTAGE
1	Less than 10%	Clear	5%
2	10% - 25%	Small scattered Clouds	17.5%
3	26% - 50%	Large scattered Clouds	
4	51% - 99%	Broken or Connected Clouds	38%
5	100%	Complete overcast	75%
			100%

Handle Via
~~TALENT KEYHOLE~~
Control System Only

2. Cloud Cover Data, Missions 1015-1 and 1015-2
PERCENTAGE OF CLOUD COVER CATEGORIES BY PASSES

Pass Number	Mission 1015-1					Mission 1015-2							
	1	2	3	4	5	Cloud Cover % Per Pass	1	2	3	4	5	Cloud Cover % Per Pass	
3D	47.7	0.8	4.6	24.2	22.7	45.2	83D	62.4	18.8	13.6	5.2	0.0	15.5
4D	56.1	13.9	12.3	16.4	1.3	23.5	84D	39.4	12.8	15.8	27.6	4.4	35.3
5D	80.6	8.2	10.4	0.8	0.0	10.0	85D	25.1	5.8	12.1	56.3	0.7	49.8
6D	46.1	5.8	9.7	35.2	7.2	39.1	86D	33.2	4.5	7.6	42.1	12.6	49.6
8D	41.1	8.9	9.8	31.3	8.9	39.7	87D	20.6	2.4	5.9	66.9	4.2	58.1
10D	31.9	5.7	7.0	55.4	0.0	46.8	88D	51.6	10.9	9.4	28.1	0.0	29.1
14D	10.4	20.8	27.1	41.7	0.0	45.7	145D	60.7	8.3	6.0	25.0	0.0	25.5
20D	72.8	15.7	8.7	2.8	0.6	11.8	146D	56.6	4.4	9.6	29.4	0.0	29.3
21D	69.6	4.6	6.5	18.7	0.6	21.3	147D	51.6	10.7	10.7	27.0	0.0	28.8
22D	43.6	13.3	15.0	28.1	0.0	31.3	148D	25.5	3.3	7.3	59.2	4.7	53.7
24D	32.9	22.2	11.9	32.4	0.6	34.9	149D	49.5	4.2	8.1	38.2	0.0	34.9
26D	0.0	4.5	18.7	76.8	0.0	65.5	150D	31.8	5.6	4.0	32.1	26.5	54.7
30D	25.7	9.0	17.4	47.9	0.0	45.4	151D	23.1	4.0	14.7	43.0	15.2	54.9
35D	37.3	1.3	22.4	39.0	0.0	39.9	152D	7.0	2.1	9.4	81.5	0.0	65.4
36D	29.9	12.3	12.0	26.1	19.7	47.5	161D	64.5	5.7	29.8	0.0	0.0	15.6
37D	37.7	13.7	18.1	28.7	1.8	34.5	162D	44.3	22.0	19.8	13.9	0.0	24.0
38D	38.5	7.5	7.6	45.4	1.0	41.2	164D	51.6	11.0	13.9	20.9	2.6	28.0
39D	52.0	6.9	10.6	30.2	0.3	30.8	165D	61.7	3.1	4.6	27.4	3.2	29.0
41D	10.5	11.2	16.5	61.8	0.0	55.1	166D	28.9	1.7	6.3	32.7	30.4	59.0
52D	42.0	15.8	19.7	22.8	0.0	29.2	167D	6.1	4.7	4.0	53.1	32.1	74.5
53D	48.3	14.3	15.8	20.5	1.1	27.4	168D	0.0	0.0	1.6	54.3	44.1	85.4
54D	32.7	13.6	13.3	25.6	14.8	43.1	172D	15.8	4.4	17.3	59.6	2.9	55.7
57D	82.7	2.0	6.1	7.7	1.5	14.1		35.4*	6.6*	10.1*	39.8*	8.1*	44.7**
66D	62.7	15.6	13.2	8.5	0.0	17.2							
67D	66.2	14.5	6.7	12.6	0.0	17.8							
69D	41.2	5.7	11.7	18.4	23.0	44.3							
70D	48.4	4.9	7.6	27.9	11.2	38.3							
71D	46.7	16.5	9.7	24.5	2.6	29.9							
73D	1.1	10.8	31.3	54.5	2.3	57.0							
77D	57.6	35.4	7.0	0.0	0.0	11.7							
	46.4*	10.6*	11.7*	26.7*	4.6*	33.2**							

*Average percentage by category for mission.
**Overall mission cloud cover percentage.

APPENDIX F. MISSION COVERAGE STATISTICS

Summary of Plottable Photographic Coverage Mission 1015-1

Country	19-24 December 1964Z Fwd Camera		20-24 December 1964Z Aft Camera		20-24 December 1964Z Fwd and Aft Cameras	
	Linear nm	Square nm	Linear nm	Square nm	Linear nm	Square nm
USSR	10,540	1,593,274	10,902	1,654,526	21,442	3,247,800
Cuba	4,830	695,334	4,742	699,602	9,572	1,394,936
Republic of Congo (Both)	836	128,728	836	128,728	1,672	257,456
Indonesia	635	77,216	656	79,648	1,291	156,864
Cuba	385	38,880	472	42,048	857	80,928
Union of Central African Republic	365	55,812	386	59,088	751	114,900
West Germany	296	46,768	286	41,544	582	88,312
Mongolia	277	43,780	296	46,952	573	90,732
Laos	241	28,256	184	21,168	425	49,424
Mexico	238	31,020	142	18,250	380	49,270
Japan	213	16,748	102	8,058	315	24,806
East Germany	172	27,176	217	34,286	389	61,462
Poland	164	23,384	131	18,644	295	42,028
Burma	148	21,608	152	19,262	300	40,870
South Korea	129	5,850	129	3,900	258	9,750
India	102	14,892	41	5,986	143	20,878
Haiti	99	4,320	62	1,728	161	6,048
Czechoslovakia	84	13,272	62	9,796	146	23,068
Taiwan	82	3,650	41	1,752	123	5,402
Angola	62	9,672			62	9,672
Bahama Islands	62	864	112	1,584	174	2,448
Iran	61	9,638	41	6,478	102	16,116
Netherlands	25	3,950	14	2,212	39	6,162
Austria	19	3,002			19	3,002
North Korea	14	450	14	2,100	28	2,550
Jamaica	14	144			12	144
Denmark	12		47	2,212	47	2,212
TOTAL	20,091	2,897,688	20,067	2,909,552	40,158	5,807,240
Continental US	977	141,546	1,078	156,398	2,055	297,944
GRAND TOTAL	21,068	3,039,234	21,145	3,065,950	42,213	6,105,184

APPENDIX F. (CONTINUED)

Summary of Plottable Photographic Coverage Mission 1015-2

Country	25 & 28-30 December 1964Z Fwd Camera		25 & 28-30 December 1964Z Aft Camera		25 & 28-30 December 1964Z Fwd and Aft Cameras	
	Linear nm	Square nm	Linear nm	Square nm	Linear nm	Square nm
USSR	9,636	1,322,586	9,764	1,338,328	19,400	2,660,914
China	3,879	558,576	3,835	552,240	7,714	1,110,816
Republic of Congo (Both)	911	151,226	911	151,226	1,822	302,452
Mongolia	614	88,416	628	90,432	1,242	178,848
Indonesia	378	43,990	378	43,990	756	87,980
Angola	248	41,168	331	54,946	579	96,114
Cuba	228	20,276	257	22,792	485	43,068
Egypt	226	32,544	205	29,520	431	62,064
Laos	246	36,408	179	26,492	425	62,900
North Vietnam	201	29,664	173	25,572	374	55,236
Rumania	185	26,640	158	22,752	343	49,392
Poland	148	21,904	148	21,904	296	43,808
Union of Central African Republic	104	16,766	161	25,982	265	42,748
Iran	144	21,024	62	9,052	206	30,076
Malaysia	94	15,604	94	14,110	188	29,714
Turkey	82	11,972	103	7,592	185	19,564
Sweden	21	592	82	4,884	103	5,476
Thailand	66	9,768	27	3,996	93	13,764
Jamaica	57	5,920	29	888	86	6,808
Bulgaria	62	4,464			62	4,464
Mexico	11	1,584			11	1,584
Cameroon			4	664	4	664
TOTAL	17,541	2,461,092	17,529	2,447,362	35,070	4,908,454
Continental US	738	106,272	703	101,232	1,441	207,504
GRAND TOTAL	18,279	2,567,364	18,232	2,548,594	36,511	5,115,958

~~TOP SECRET RUFF~~

~~NO FOREIGN DISSEM~~

Handle Via
~~TALENT KEYHOLE~~
Control System Only



APPROXIMATE TRACK MISSION 1015-1, 20-24 DECEMBER 1964 OVER USSR, FAR AND MIDDLE EAST.

~~TOP SECRET RUFF~~

~~NO FOREIGN DISSEM~~

Handle Via
~~TALENT KEYHOLE~~
Control System Only

~~TOP SECRET RUFF~~

~~NO FOREIGN DISSEM~~

Handle Via
TALENT-KEYHOLE
Control System Only

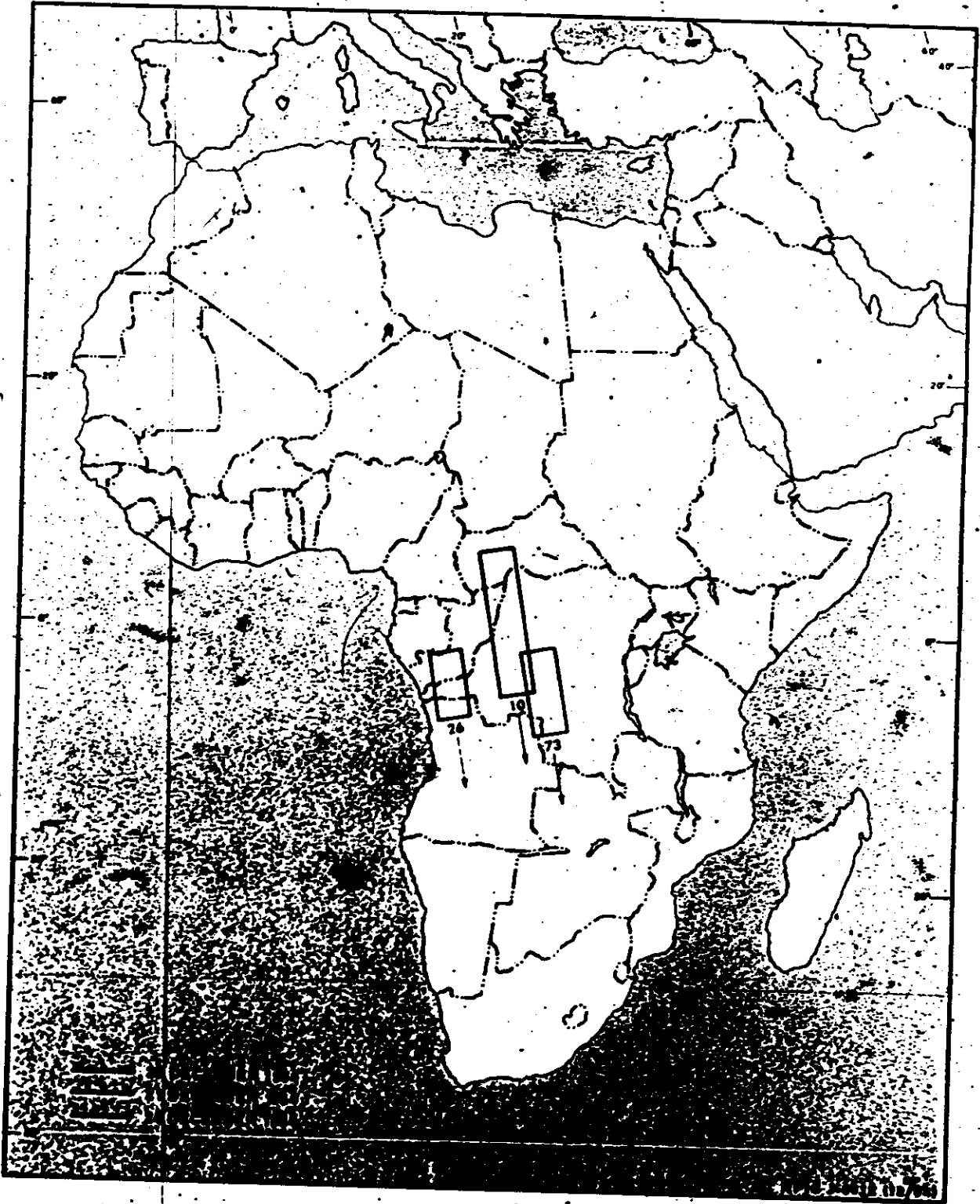

APPROXIMATE TRACK MISSION 1015-1, 20-24 DECEMBER 1964 OVER AFRICA.

- 67 -

~~TOP SECRET RUFF~~

~~NO FOREIGN DISSEM~~

Handle Via
TALENT-KEYHOLE
Control System Only

Handle Via
~~TALENT KEYHOLE~~
Control System Only

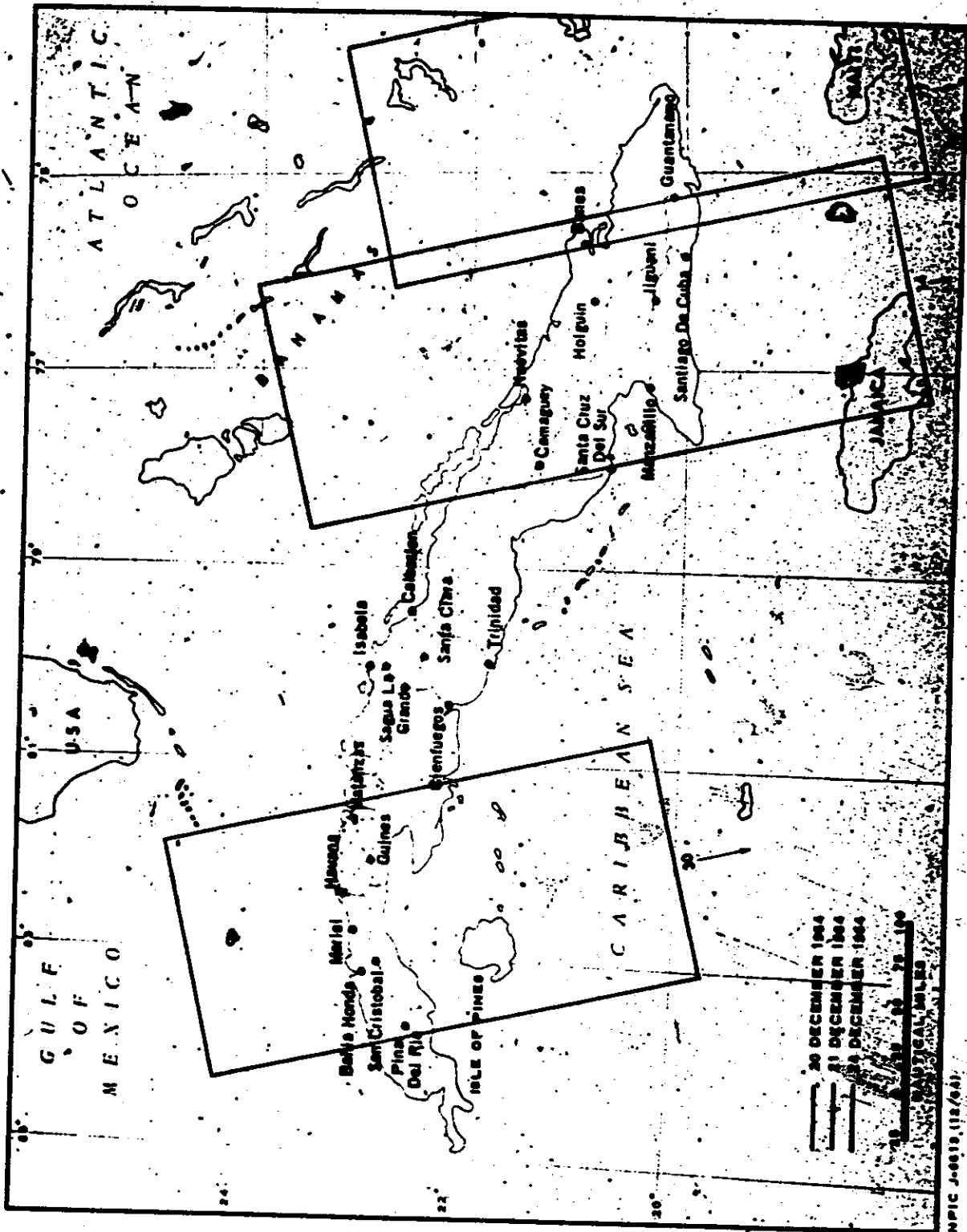

APPROXIMATE TRACK MISSION 1015-1, 20-24 DECEMBER 1964 OVER CUBA.

NPIC J-0019 (112/64)

Handle Via
~~TALENT KEYHOLE~~
Control System Only

~~TOP SECRET RUFF~~

~~NO FOREIGN DISSEM~~

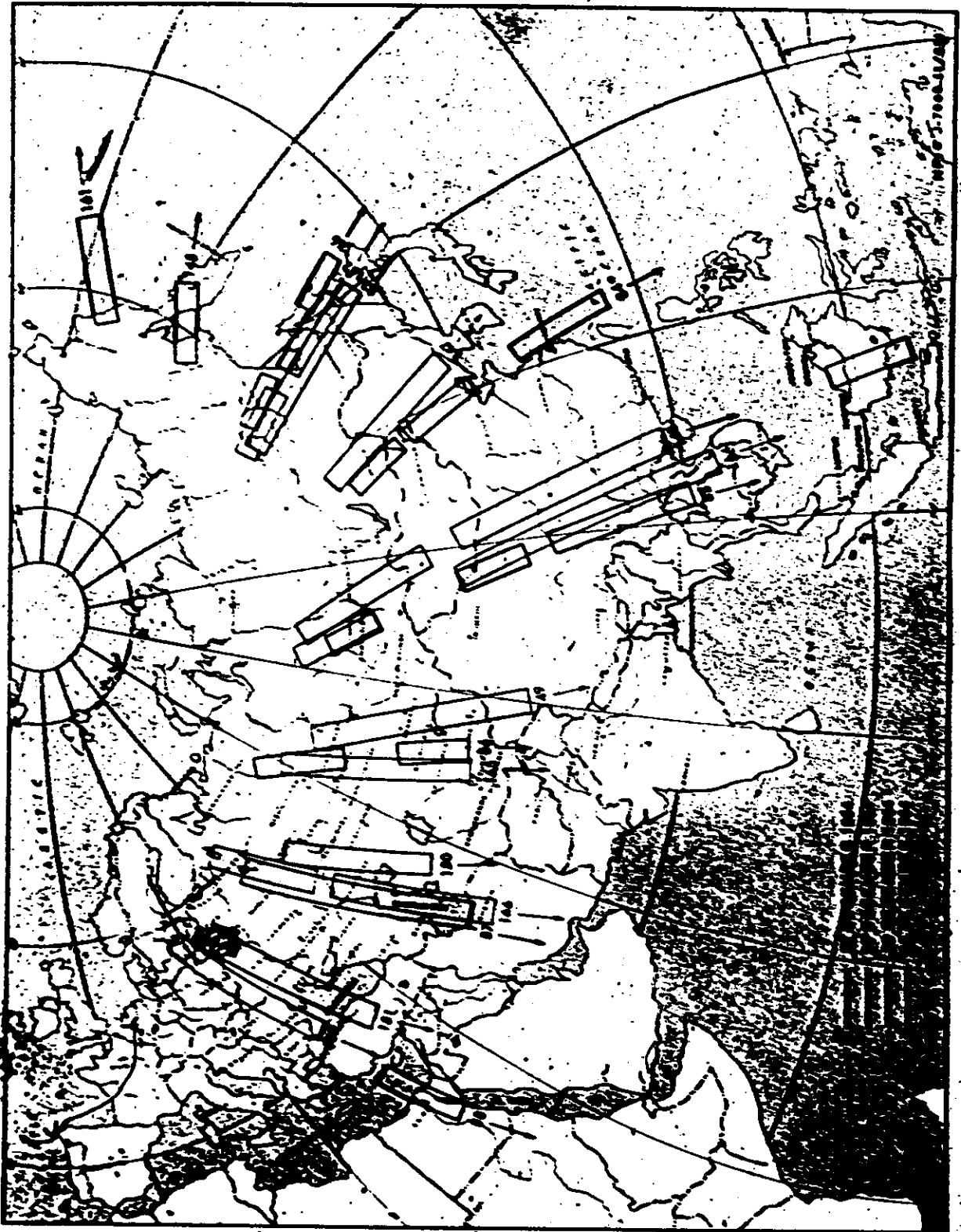

APPROXIMATE TRACK OF MISSION 1015-2, 21, 28-30 DECEMBER 1964 OVER USSR, FAR AND MIDDLE EAST.

- 71 -

~~TOP SECRET RUFF~~

~~NO FOREIGN DISSEM~~

Handle Via
TALCOT-REWHOLE
Control System Only

~~TOP SECRET RUFF~~

~~NO FOREIGN DISSEM~~

Handle Via
~~TALENT KEYHOLE~~
Control System Only

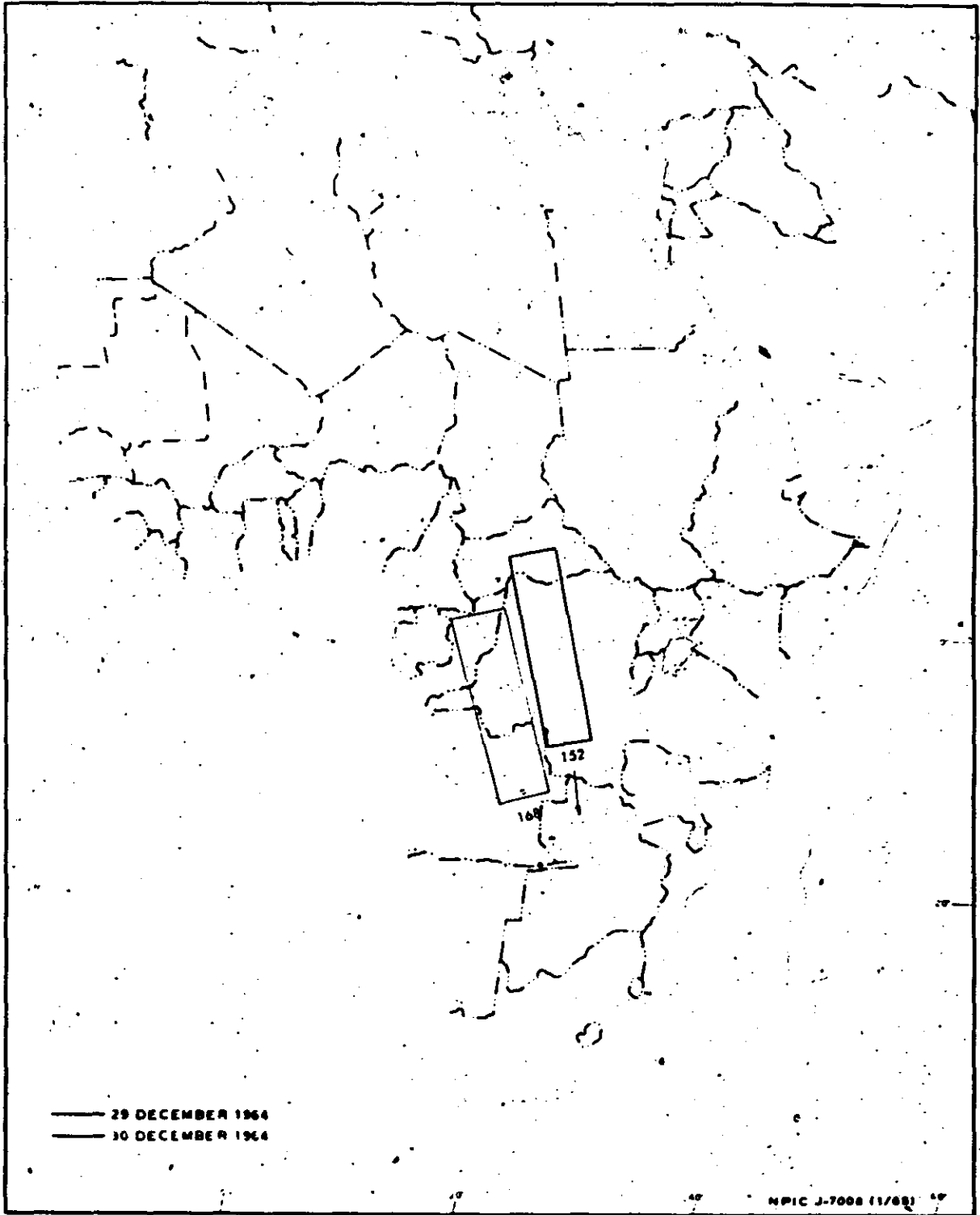

APPROXIMATE TRACK OF MISSION 1015-2, 25, 28-30 DECEMBER 1964 OVER AFRICA.

- 75 -

~~TOP SECRET RUFF~~

~~NO FOREIGN DISSEM~~

Handle Via
~~TALENT KEYHOLE~~
Control System Only